



## Table of Contents

<b>Block Diagram</b> .....	<b>3</b>
<b>Ordering Information</b> .....	<b>3</b>
<b>Pin Configuration</b> .....	<b>4</b>
<b>Pin Descriptions</b> .....	<b>4</b>
<b>Absolute Maximum Ratings</b> .....	<b>6</b>
<b>Thermal Information</b> .....	<b>6</b>
<b>Recommended Operating Conditions</b> .....	<b>6</b>
<b>Electrical Specifications</b> .....	<b>6</b>
<b>Typical Performance Curves</b> .....	<b>11</b>
<b>Functional Description</b> .....	<b>21</b>
Overview .....	21
Functional Pin Descriptions .....	21
<b>Communication Protocol</b> .....	<b>23</b>
Packet Error Correction (PEC) .....	23
IC Device Details .....	24
Global IC Controls .....	25
Primary and Auxiliary Channel Controls .....	25
Measurement Registers .....	28
Threshold Detectors .....	29
SMB Alert .....	31
External Clock Control .....	35
<b>Serial Interface</b> .....	<b>36</b>
Protocol Conventions .....	36
SMBus, PMBus Support .....	37
Device Addressing .....	37
Write Operation .....	38
Read Operation .....	38
Group Command .....	38
Clock Speed .....	38
<b>Signal Integrity</b> .....	<b>39</b>
Fast Transients .....	39
External Clock .....	40
Overranging .....	41
Shunt Resistor Selection .....	41
A Trace as a Sense Resistor .....	44
Lossless Current Sensing (DCR) .....	45
<b>Revision History</b> .....	<b>46</b>
<b>About Intersil</b> .....	<b>46</b>
<b>Package Outline Drawing</b> .....	<b>47</b>

## Block Diagram

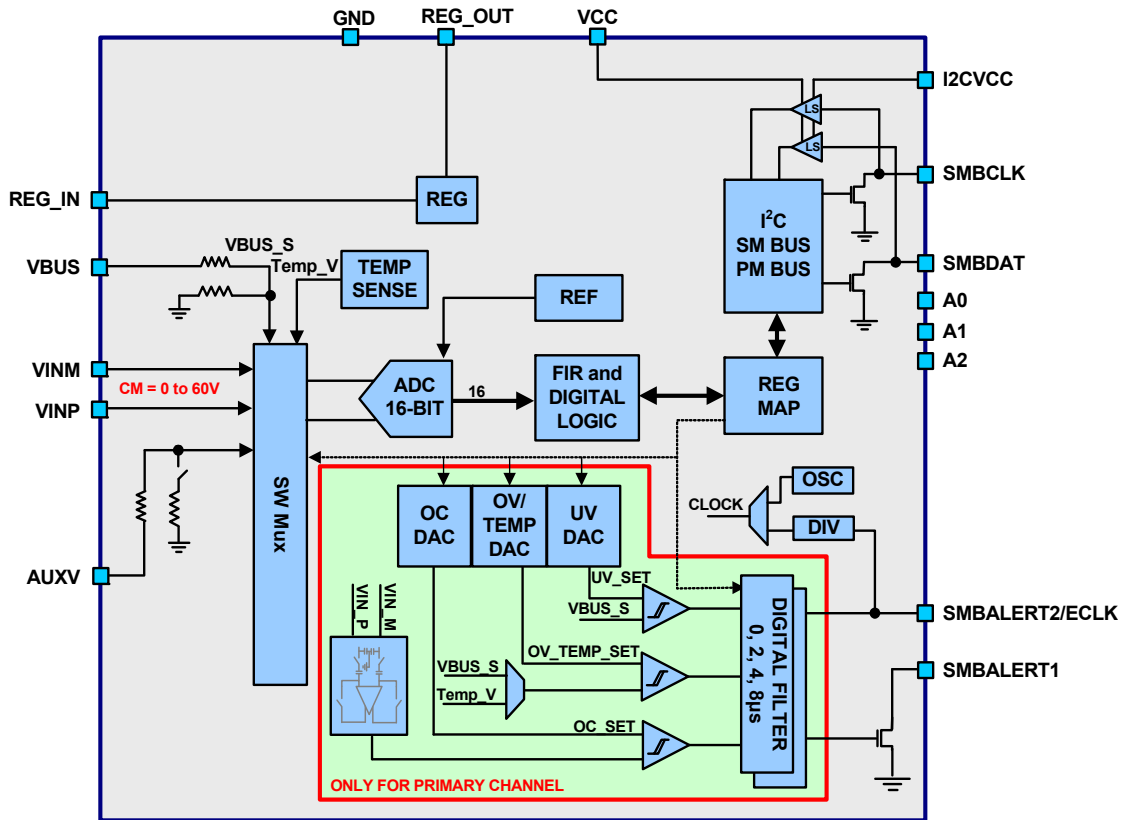

FIGURE 2. BLOCK DIAGRAM

## Ordering Information

PART NUMBER (Notes 1, 2, 3)	PART MARKING	V <sub>BUS</sub> OPTION (V)	PACKAGE (RoHS Compliant)	PKG. DWG. #
ISL28025FI12Z-T	2512	12	16 Ball WLCSP	W4x4.16C
ISL28025FI12Z-T7A	2512	12	16 Ball WLCSP	W4x4.16C
ISL28025FI60Z-T	2560	60	16 Ball WLCSP	W4x4.16C
ISL28025FI60Z-T7A	2560	60	16 Ball WLCSP	W4x4.16C
ISL28025EVKIT1Z	Evaluation Kit			
ISL28025EVAL1Z	Evaluation Board			

### NOTES:

1. Please refer to [TB347](#) for details on reel specifications.
2. Intersil Pb-free WLCSP and BGA packaged products employ special Pb-free material sets; molding compounds/die attach materials and SnAgCu - e1 solder ball terminals, which are RoHS compliant and compatible with both SnPb and Pb-free soldering operations. Intersil Pb-free WLCSP and BGA packaged products are MSL classified at Pb-free peak reflow temperatures that meet or exceed the Pb-free requirements of IPC/JEDEC J STD-020.
3. For Moisture Sensitivity Level (MSL), please see product information page for [ISL28025](#). For more information on MSL please see techbrief [TB363](#).

# ISL28025

## Pin Configuration

ISL28025  
(16 BALL 0.5mm PITCH WLCSP)  
TOP VIEW

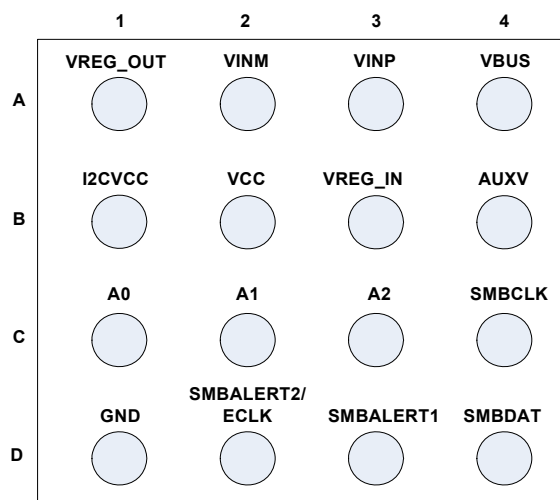

## Pin Descriptions

16 PIN WLCSP	PIN NAME	TYPE/DIR	PIN DEFINITION
A1	VREG_OUT	Power	Voltage regulator output, proper decoupling cap should be connected to this pin.
A2	VINM	Analog Input	Current sense minus input
A3	VINP	Analog Input	Current sense plus input
A4	VBUS	Power	VBus voltage sense
B1	I2CVCC	Power	I <sup>2</sup> C level shifter power supply, this pin should be connected to VCC pin if level shifters are not used.
B2	VCC	Power	Chip power supply
B3	VREG_IN	Power	Voltage regulator input. This pin should be connected to ground in case voltage regulator is not used.
B4	AUXV	Analog Input	Auxiliary port single-ended input
C1	A0	Digital Input	I <sup>2</sup> C address input
C2	A1	Digital Input	I <sup>2</sup> C address input
C3	A2	Digital Input	I <sup>2</sup> C address input
C4	SMBCLK	Digital Input	SMBus/I <sup>2</sup> C clock input
D1	GND	Power	Ground
D2	SMBALERT2/ECLK	Digital Input/Output	External ADC clock input or CPU interrupt signal. It is used as CPU interrupt signal only when this pin is not configured as external clock input.
D3	SMBALERT1	Digital Output	SMBus Alert1, open collector output
D4	SMBDAT	Digital Input	SMBus/I <sup>2</sup> C data

# ISL28025

TABLE 1. DPM PORTFOLIO COMPARISON - ISL28022 vs ISL28023 vs ISL28025

DESCRIPTION		BASIC DIGITAL POWER MONITOR	FULL FEATURE DIGITAL POWER MONITOR	DIGITAL POWER MONITOR IN TINY PACKAGE
PART NUMBER		ISL28022	ISL28023	ISL28025
PACKAGE		MSOP10, QFN16	QFN24	WLCSP-16
Temperature Range		-40°C to +125°C	-40°C to +125°C	-40°C to +125°C
0V to 60V Input Range		0V to 60V	Opt 1: 0V to 60V Opt 2: 0V to 16V	Opt 1: 0V to 60V Opt 2: 0V to 16V
ADC		16-bit	16-bit	16-bit
25°C Gain Error		0.30%	0.25%	0.25%
Current Measure LSB Step		10µV	2.5µV	2.5µV
25°C Offset		75µV	30µV	30µV
Primary	Differential Shunt Input	X	X	X
Channel	Independent Bus Voltage	X	X	X
LV Aux	Differential Shunt Input		X	
Channel	Independent Bus Voltage		X	X
VBus LSB Step	Low Voltage Bus		0.25mV	0.25mV
	High Voltage Bus	4mV	1mV/0.25mV	1mV/0.25mV
External Temperature Sensor Input			X	
HV Internal Regulator (3.3V <sub>OUT</sub> )			X	X
Fast OC/OV/UV Alert Outputs			2 Outputs	2 Outputs
Margin DAC			X	
Internal Temperature Sensor			X	X
User Select Conversion Mode/Sample Rate		X	X	X
Peak Min/Max Current Registers			X	X
Slave Address Locations		16 Addresses	55 Addresses	55 Addresses
I <sup>2</sup> C Level Translators			X	X
PMBus			X	X
I <sup>2</sup> C/SMBus		X	X	X
High Speed (3.4MHz) I <sup>2</sup> C Mode		X	X	X
External Clock Input		X	X	X
Power Shutdown Mode		X	X	X

# ISL28025

## Absolute Maximum Ratings

VCC	6.0V
I2C_VCC Voltage	6.0V
VBUS (ISL28025FI60), REG_IN	63V
VBUS (ISL28025FI12)	16.684V
Common Mode Input Voltage (VINP, VINM)	63V
Differential Input Voltage (VINP, VINM)	±63V
AUXV	VCC - GND
Input Voltage (Digital Pins)	GND - 0.3 to I2CVCC + 0.3V
Output Voltage (Digital Pins)	GND - 0.3 to I2CVCC + 0.3V
Output Current (REG_OUT)	10mA
Open Drain Output Current	10mA
Open Drain Voltage (SMBALERT1)	24V
ESD Ratings	
Human Body Model	6kV
Machine Model	300V
Charged Device Model	2kV
Latch-up	±100mA (at +125°C)

## Thermal Information

Thermal Resistance (Typical)	$\theta_{JA}$ (°C/W)	$\theta_{JC}$ (°C/W)
16 Ball WLCSP (Notes 4, 5)	80	1
Maximum Storage Temperature Range	-65°C to +150°C	
Maximum Junction Temperature (T <sub>JMAX</sub> )	+150°C	
Pb-free Reflow Profile	see <a href="#">TB493</a>	

## Recommended Operating Conditions

Ambient Temperature Range (T <sub>A</sub> )	-40°C to +125°C
---	-----------------

**CAUTION:** Do not operate at or near the maximum ratings listed for extended periods of time. Exposure to such conditions may adversely impact product reliability and result in failures not covered by warranty.

### NOTES:

- $\theta_{JA}$  is measured in free air with the component mounted on a high effective thermal conductivity test board with “direct attach” features. See Tech Brief [TB379](#).
- For  $\theta_{JC}$ , the “case temp” location is taken at the package top center.

**Electrical Specifications** T<sub>A</sub> = +25°C, I<sup>2</sup>CVCC = V<sub>CC</sub> = 3.3V, V<sub>INP</sub> = V<sub>BUS</sub> = 12V, V<sub>SENSE</sub> = V<sub>INP</sub> - V<sub>INM</sub> = 80mV, Aux V = 3V, Conversion Time: Aux = Primary = 2.05ms, Internal AVG Aux = Primary = 128, unless otherwise specified. All voltages with respect to GND pin. Temperature limits established by characterization.

PARAMETER	DESCRIPTION	TEST CONDITIONS	MIN (Note 6)	TYP	MAX (Note 6)	UNITS
<b>PRIMARY CHANNEL</b>						
V <sub>SHUNT</sub>	V <sub>SHUNT</sub> Measurement Range (V <sub>INP</sub> to V <sub>INM</sub> )		0		±81.91	mV
Step_shunt	1LSB Step Shunt Voltage			2.5		µV
Vshunt_vos	V <sub>SHUNT</sub> Offset Voltage			±2.5	±50	µV
Vshunt_TC	V <sub>SHUNT</sub> Offset Voltage vs Temperature	T = -40°C to +125°C		±0.04	±0.3	µV/°C
Vshunt_CMRR	V <sub>SHUNT</sub> Vos vs Common Mode	ISL28025FI60Z V <sub>BUS</sub> = 0V to 60V		±0.2	±2	µV/V
		ISL28025FI12Z V <sub>BUS</sub> = 0V to 16.384V		±0.2	±2	µV/V
Vshunt_PSR	V <sub>SHUNT</sub> Vos vs Power Supply	V <sub>CC</sub> = ±10% of V <sub>CC</sub> nominal		±0.45		µV/V
I <sub>vin</sub>	V <sub>IN</sub> Input Leakage Current	V <sub>IN</sub> = V <sub>SHUNT</sub> input path selected, OC detector disabled		15	20	µA
		V <sub>IN</sub> = V <sub>SHUNT</sub> input path selected, OC detector enabled		30	40	µA
		V <sub>IN</sub> = V <sub>SHUNT</sub> input path disabled, OC detector disabled		0.05	0.1	µA
V <sub>bus</sub>	Usable Bus Voltage Measurement Range	ISL28025FI60Z	0		60	V
		ISL28025FI12Z	0		16.384	V
Step_Vbus	1LSB Step Bus Voltage	ISL28025FI60Z		1		mV
		ISL28025FI12Z		0.25		mV
V <sub>bus_vos</sub>	V <sub>BUS</sub> Offset Voltage	ISL28025FI60Z	-20	±1	20	mV
		ISL28025FI12Z	-5	±0.25	5	mV

# ISL28025

**Electrical Specifications**  $T_A = +25^\circ\text{C}$ ,  $I^2\text{CVCC} = V_{\text{CC}} = 3.3\text{V}$ ,  $V_{\text{INP}} = V_{\text{BUS}} = 12\text{V}$ ,  $V_{\text{SENSE}} = V_{\text{INP}} - V_{\text{INM}} = 80\text{mV}$ ,  $\text{Aux V} = 3\text{V}$ , Conversion Time:  $\text{Aux} = \text{Primary} = 2.05\text{ms}$ , Internal AVG  $\text{Aux} = \text{Primary} = 128$ , unless otherwise specified. All voltages with respect to GND pin. Temperature limits established by characterization. (Continued)

PARAMETER	DESCRIPTION	TEST CONDITIONS	MIN (Note 6)	TYP	MAX (Note 6)	UNITS
Vbus_TC	V <sub>BUS</sub> Offset Voltage vs Temperature	ISL28025FI60Z; T = -40°C to +125°C		±4	±100	μV/°C
		ISL28025FI12Z; T = -40°C to +125°C		±1	±100	μV/°C
Vbus_Vco	V <sub>BUS</sub> Voltage Coefficient			50		ppm/V
Vbus_PSRR	V <sub>BUS</sub> Vos vs Power Supply	ISL28025FI60Z; V <sub>CC</sub> = ±10% of V <sub>CC</sub> nominal		±500		μV/V
		ISL28025FI12Z V <sub>CC</sub> = ±10% of V <sub>CC</sub> nominal		±125		μV/V
Zin_Vbus	Input Impedance V <sub>BUS</sub>	ISL28025FI60Z		600		kΩ
		ISL28025FI12Z		150		kΩ
<b>AUX CHANNEL</b>						
Vauxv	Usable AVXV Voltage Measurement Range		0		VCC	V
Step_auxv	1LSB Step AUXV Voltage			100		μV
Vauxv_vos	V <sub>AUXV</sub> Offset Voltage			±0.3	±4	mV
Vauxv_TC	V <sub>AUXV</sub> Offset Voltage vs Temperature	T = -40°C to +125°C		±0.2	±22	μV/°C
Vauxv_PSRR	V <sub>AUXV</sub> Vos vs Power Supply	V <sub>CC</sub> = ±10% of V <sub>CC</sub> nominal		±1		mV/V
Zin_auxv	Auxv Input Impedance	Input path selected		200		kΩ
		Input path disabled		10		MΩ
<b>ADC PARAMETERS</b>						
	ADC Resolution			16		Bits
	Primary Shunt Voltage Gain Error			±0.05	±0.25	%
		T = -40°C to +125°C		0	±60	ppm/°C
	Primary Bus Voltage Gain Error			±0.05	±0.25	%
		T = -40°C to +125°C		10	±70	ppm/°C
	Aux Bus Voltage Gain Error			±0.05	±0.25	%
		T = -40°C to +125°C		10	±65	ppm/°C
	Differential Nonlinearity			±1		LSB
<b>ADC TIMING</b>						
t <sub>s</sub> Power-up	ADC Conversion Time Resolution	ADC[2:0] = 0h		64	70.4	μs
		ADC[2:0] = 1h		128	140.8	μs
		ADC[2:0] = 2h		256	281.6	μs
		ADC[2:0] = 3h		512	563.2	μs
		ADC[2:0] = 4, 5h		1.024	1.126	ms
		ADC[2:0] = 6, 7h		2.048	2.253	ms

# ISL28025

**Electrical Specifications**  $T_A = +25^\circ\text{C}$ ,  $I^2\text{CVCC} = V_{\text{CC}} = 3.3\text{V}$ ,  $V_{\text{INP}} = V_{\text{BUS}} = 12\text{V}$ ,  $V_{\text{SENSE}} = V_{\text{INP}} - V_{\text{INM}} = 80\text{mV}$ , Aux V = 3V, Conversion Time: Aux = Primary = 2.05ms, Internal AVG Aux = Primary = 128, unless otherwise specified. All voltages with respect to GND pin. Temperature limits established by characterization. (Continued)

PARAMETER	DESCRIPTION	TEST CONDITIONS	MIN (Note 6)	TYP	MAX (Note 6)	UNITS
<b>THRESHOLD DETECTORS</b>						
	Overvoltage (OV) $V_{\text{BUS}}$ Threshold Voltage Range	Vbus_Thres_Rng[2:0] = ALL	25		125	% of FS
	Overvoltage (OV) $V_{\text{BUS}}$ Threshold DAC Step Size	Vbus_Thres_Rng[2:0] = ALL		1.56		% of FS
	Undervoltage (UV) $V_{\text{BUS}}$ Threshold Voltage Range	Vbus_Thres_Rng[2:0] = ALL	0		100	% of FS
	Undervoltage (UV) $V_{\text{BUS}}$ Threshold DAC Step Size	Vbus_Thres_Rng[2:0] = ALL		1.56		% of FS
	$V_{\text{BUS}}$ Threshold Detector Full-scale Settings ISL28025FI60Z	Vbus_Thres_Rng[2:0] = 0; OT_SEL = 0		48		V
		Vbus_Thres_Rng[2:0] = 1; OT_SEL = 0		24		V
		Vbus_Thres_Rng[2:0] = 2; OT_SEL = 0		12		V
		Vbus_Thres_Rng[2:0] = 3; OT_SEL = 0		5		V
		Vbus_Thres_Rng[2:0] = 4; OT_SEL = 0		3.3		V
		Vbus_Thres_Rng[2:0] = 5; OT_SEL = 0		2.5		V
	$V_{\text{BUS}}$ Threshold Detector Full-scale Settings ISL28025FI12Z	Vbus_Thres_Rng[2:0] = 0; OT_SEL = 0		12		V
		Vbus_Thres_Rng[2:0] = 1; OT_SEL = 0		6		V
		Vbus_Thres_Rng[2:0] = 2; OT_SEL = 0		3		V
		Vbus_Thres_Rng[2:0] = 3; OT_SEL = 0		2.5		V
		Vbus_Thres_Rng[2:0] = 4; OT_SEL = 0		0.825		V
		Vbus_Thres_Rng[2:0] = 5; OT_SEL = 0		0.625		V
	Over-temperature Threshold Detector Range	OT_SEL = 1	-40		135	$^\circ\text{C}$
	Over-temperature Threshold Detector Resolution Error			$\pm 5$		$^\circ\text{C}$
	Overcurrent (OC) $V_{\text{SHUNT}}$ Threshold Voltage Range	OCRNG = ALL	25		125	% of FS
	Overcurrent (OC) $V_{\text{SHUNT}}$ Threshold DAC Step Size	OCRNG = ALL		1.56		% of FS
	$V_{\text{SHUNT}}$ Threshold Detector Full Scale Settings	OCRNG = 0		80		mV
		OCRNG = 1		40		mV
<b>VOLTAGE REGULATOR SPECIFICATION</b>						
	Input Voltage at REG_IN		4.5		60	V
	Output Regulation Voltage		3.18	3.3	3.35	V
	Line Regulation	$V_{\text{IN}} 4.5\text{V to }60\text{V}$		53	150	$\mu\text{V/V}$
	Load Regulation	$I_{\text{LOAD}} = 3.3\text{mA to }6\text{mA}$		0.2	1.4	mV/mA
	Capacitance Drive		0.01		10	$\mu\text{F}$
	Output Short Circuit	$T = -40^\circ\text{C to }+125^\circ\text{C}$		10		mA
	Max Load Current	$T = -40^\circ\text{C to }+125^\circ\text{C}$		6		mA
	Start-up time			1		ms



# ISL28025

**Electrical Specifications**  $T_A = +25^\circ\text{C}$ ,  $I^2\text{CVCC} = V_{\text{CC}} = 3.3\text{V}$ ,  $V_{\text{INP}} = V_{\text{BUS}} = 12\text{V}$ ,  $V_{\text{SENSE}} = V_{\text{INP}} - V_{\text{INM}} = 80\text{mV}$ , Aux V = 3V, Conversion Time: Aux = Primary = 2.05ms, Internal AVG Aux = Primary = 128, unless otherwise specified. All voltages with respect to GND pin. Temperature limits established by characterization. (Continued)

PARAMETER	DESCRIPTION	TEST CONDITIONS	MIN (Note 6)	TYP	MAX (Note 6)	UNITS
<b>TEMPERATURE SENSOR</b>						
	Temperature Sensor Measurement Range		-40		125	$^\circ\text{C}$
	Temperature Accuracy	$T = +25^\circ\text{C}$		+3.2		$^\circ\text{C}$
	Temperature Resolution			0.5		$^\circ\text{C}$
	Measurement Time			0.5		ms
<b>SMBus/I<sup>2</sup>C INTERFACE SPECIFICATIONS</b>						
$V_{\text{IL}}$	SMBDAT and SMBCLK Input Buffer LOW Voltage		-0.3		$0.3 \times I^2\text{CVCC}$	V
$V_{\text{IH}}$	SMBDAT and SMBCLK Input Buffer HIGH Voltage		$0.7 \times I^2\text{CVCC}$		$I^2\text{CVCC} + 0.3$	V
Hysteresis	SMBDAT and SMBCLK Input Buffer Hysteresis			$0.05 \times I^2\text{CVCC}$		V
$V_{\text{OL}}$	SMBDAT Output Buffer LOW Voltage, Sinking 3mA	$I^2\text{CVCC} = 5\text{V}$ , $I_{\text{OL}} = 3\text{mA}$	0	0.02	0.4	V
$C_{\text{PIN}}$	SMBDAT and SMBCLK Pin Capacitance	$T_A = +25^\circ\text{C}$ , $f = 1\text{MHz}$ , $I^2\text{CVCC} = 5\text{V}$ , $V_{\text{IN}} = 0\text{V}$ , $V_{\text{OUT}} = 0\text{V}$			10	pF
$f_{\text{SMBCLK}}$	SMBCLK Frequency				400	kHz
$t_{\text{IN}}$	Pulse Width Suppression Time at SMBDAT and SMBCLK Inputs	Any pulse narrower than the max spec is suppressed			50	ns
$t_{\text{AA}}$	SMBCLK Falling Edge to SMBDAT Output Data Valid	SMBCLK falling edge crossing 30% of $I^2\text{CVCC}$ , until SMBDAT exits the 30% to 70% of $I^2\text{CVCC}$ window			900	ns
$t_{\text{BUF}}$	Time the Bus Must be Free Before the Start of a New Transmission	SMBDAT crossing 70% of $I^2\text{CVCC}$ during a STOP condition, to SMBDAT crossing 70% of $I^2\text{CVCC}$ during the following START condition	1300			ns
$t_{\text{LOW}}$	Clock LOW Time	Measured at the 30% of $I^2\text{CVCC}$ crossing	1300			ns
$t_{\text{HIGH}}$	Clock HIGH Time	Measured at the 70% of $I^2\text{CVCC}$ crossing	600			ns
$t_{\text{SU:STA}}$	START Condition Setup Time	SMBCLK rising edge to SMBDAT falling edge. Both crossing 70% of $I^2\text{CVCC}$	600			ns
$t_{\text{HD:STA}}$	START Condition Hold Time	From SMBDAT falling edge crossing 30% of $I^2\text{CVCC}$ to SMBCLK falling edge crossing 70% of $I^2\text{CVCC}$	600			ns
$t_{\text{SU:DAT}}$	Input Data Setup Time	From SMBDAT exiting the 30% to 70% of $V_{\text{CC}}$ window, to SMBCLK rising edge crossing 30% of $I^2\text{CVCC}$	100			ns
$t_{\text{HD:DAT}}$	Input Data Hold Time	From SMBCLK falling edge crossing 30% of $I^2\text{CVCC}$ to SMBDAT entering the 30% to 70% of $I^2\text{CVCC}$ window	20		900	ns
$t_{\text{SU:STO}}$	STOP Condition Setup Time	From SMBCLK rising edge crossing 70% of $I^2\text{CVCC}$ , to SMBDAT rising edge crossing 30% of $I^2\text{CVCC}$	600			ns

# ISL28025

**Electrical Specifications**  $T_A = +25^\circ\text{C}$ ,  $I^2\text{CVCC} = V_{\text{CC}} = 3.3\text{V}$ ,  $V_{\text{INP}} = V_{\text{BUS}} = 12\text{V}$ ,  $V_{\text{SENSE}} = V_{\text{INP}} - V_{\text{INM}} = 80\text{mV}$ , Aux V = 3V, Conversion Time: Aux = Primary = 2.05ms, Internal AVG Aux = Primary = 128, unless otherwise specified. All voltages with respect to GND pin. Temperature limits established by characterization. (Continued)

PARAMETER	DESCRIPTION	TEST CONDITIONS	MIN (Note 6)	TYP	MAX (Note 6)	UNITS
$t_{\text{HD:STO}}$	STOP Condition Hold Time	From SMBDAT rising edge to SMBCLK falling edge. Both crossing 70% of $I^2\text{CVCC}$	600			ns
$t_{\text{DH}}$	Output Data Hold Time	From SMBCLK falling edge crossing 30% of $I^2\text{CVCC}$ , until SMBDAT enters the 30% to 70% of $I^2\text{CVCC}$ window	0			ns
$t_{\text{R}}$	SMBDAT and SMBCLK Rise Time	From 30% to 70% of $I^2\text{CVCC}$	$20 + 0.1 \times C_b$		300	ns
$t_{\text{F}}$	SMBDAT and SMBCLK Fall Time	From 70% to 30% of $I^2\text{CVCC}$	$20 + 0.1 \times C_b$		300	ns
$C_b$	Capacitive Loading of SMBDAT or SMBCLK	Total on-chip and off-chip	10		400	pF
$R_{\text{PU}}$	SMBDAT and SMBCLK Bus Pull-up Resistor Off-chip	Maximum is determined by $t_{\text{R}}$ and $t_{\text{F}}$ For $C_b = 400\text{pF}$ , max is about $2\text{k}\Omega \sim 2.5\text{k}\Omega$ . For $C_b = 40\text{pF}$ , max is about $15\text{k}\Omega \sim 20\text{k}\Omega$	1			$\text{k}\Omega$
<b>POWER SUPPLY</b>						
$V_{\text{VCC}}$	Power Supply Voltage at VCC		3.0	3.3	5.5	V
$V_{i2cvcc}$	Power Supply Voltage at $I^2\text{CVCC}$	$f = \text{DC to } 400\text{kHz}$	1.2	3.3	5.5	V
	Only ADC in Conversion mode	All other blocks are disabled		690	830	$\mu\text{A}$
	Only ADC in Idle Mode	All other blocks are disabled		640	705	$\mu\text{A}$
	Only Threshold Detectors	All three detectors are active		760	945	$\mu\text{A}$
	Fully Enabled Chip Current	All functional blocks enabled		1000	1260	$\mu\text{A}$
	Fully Disabled Chip Current	All functional blocks disabled		5	15	$\mu\text{A}$
$I_{\text{vreg\_in}}$	Voltage Regulator	$V_{\text{reg\_in}} = 4.5\text{V to } 60\text{V}$ ; $R_{\text{LOAD}} = \text{open}$		26	35	$\mu\text{A}$
$I_{i2cvcc}$	$I^2\text{C}$ Supply Current	SMBCLK = 100kHz; $I^2\text{CVCC} = 3.3\text{V}$		15		$\mu\text{A}$
$I_{i2cvcc\_pd}$	$I^2\text{C}$ Idle Supply Current	Input signals are static		100		nA

**NOTE:**

6. Parameters with MIN and/or MAX limits are 100% tested at  $+25^\circ\text{C}$ , unless otherwise specified. Compliance to datasheet limits is assured by one or more of the following methods: production test, characterization and design.

## Typical Performance Curves

$T_A = +25^\circ\text{C}$ ,  $V_{CC} = 3.3\text{V}$ ,  $V_{INP} = V_{BUS} = 12\text{V}$ ,  $Aux_v = 3\text{V}$ , conversion time;   
 Aux = Primary = 2.05ms, Internal AVG Aux = Primary = 128, unless otherwise specified.

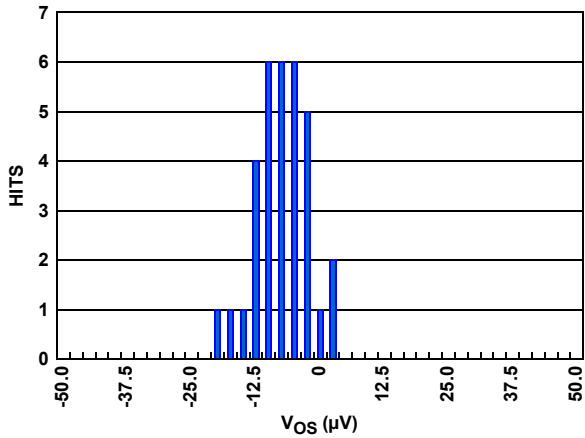

FIGURE 3. PRIMARY  $V_{SHUNT} V_{OS}$

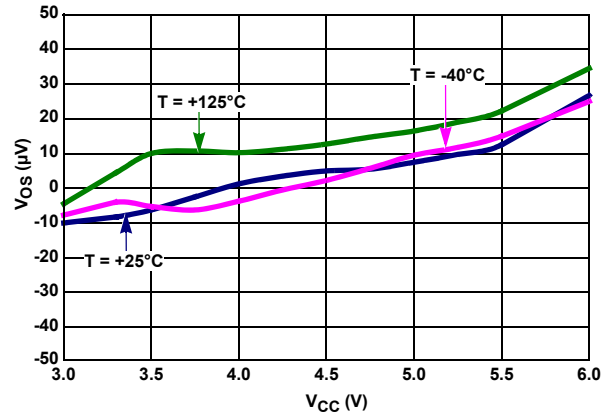

FIGURE 4. PRIMARY  $V_{SHUNT} V_{OS}$  vs  $V_{CC}$

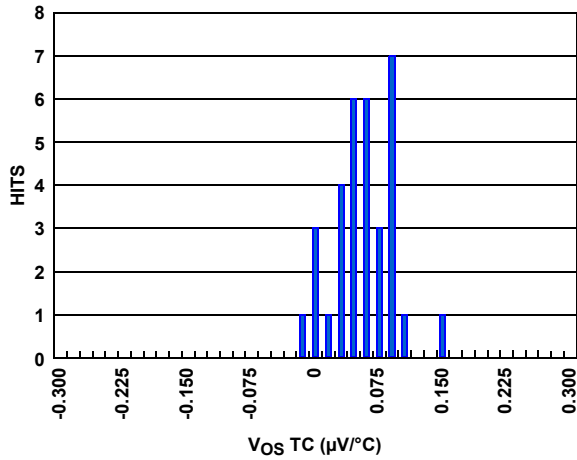

FIGURE 5. PRIMARY  $V_{SHUNT} V_{OS} TC$  ( $-40^\circ\text{C}$  TO  $+125^\circ\text{C}$ )

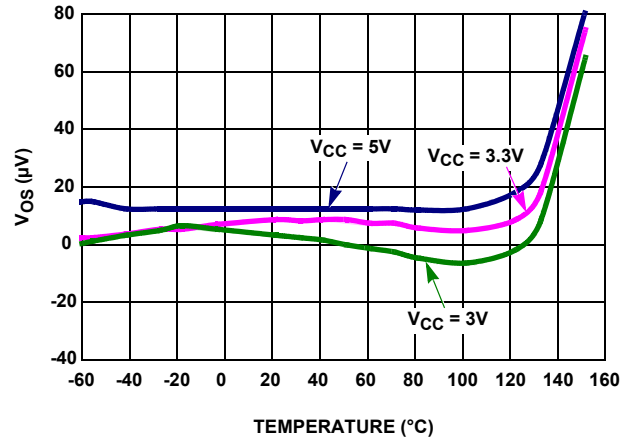

FIGURE 6. PRIMARY  $V_{SHUNT} V_{OS}$  vs TEMPERATURE

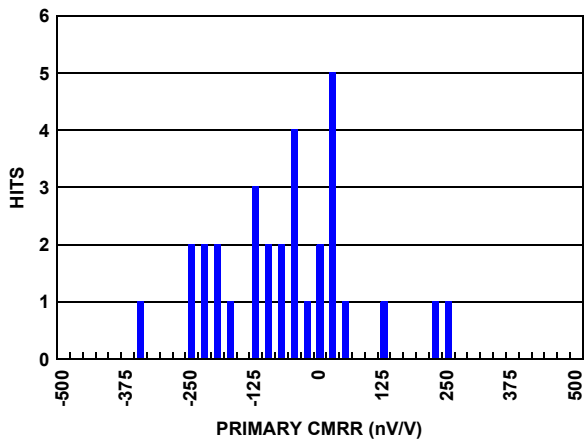

FIGURE 7. PRIMARY  $V_{SHUNT} CMRR$ ,  $CMV = (0\text{V TO } 60\text{V})$

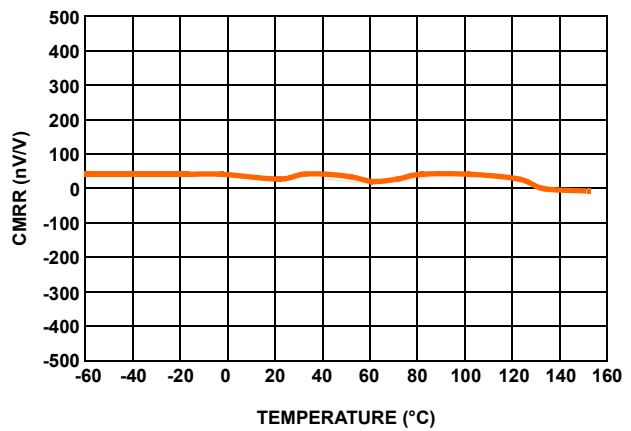

FIGURE 8. PRIMARY  $V_{SHUNT} CMRR$  vs TEMPERATURE ( $CMV = 0\text{V TO } 60\text{V}$ )

## Typical Performance Curves

$T_A = +25^\circ\text{C}$ ,  $V_{CC} = 3.3\text{V}$ ,  $V_{INP} = V_{BUS} = 12\text{V}$ ,  $Auxv = 3\text{V}$ , conversion time;   
 Aux = Primary = 2.05ms, Internal AVG Aux = Primary = 128, unless otherwise specified. (Continued)

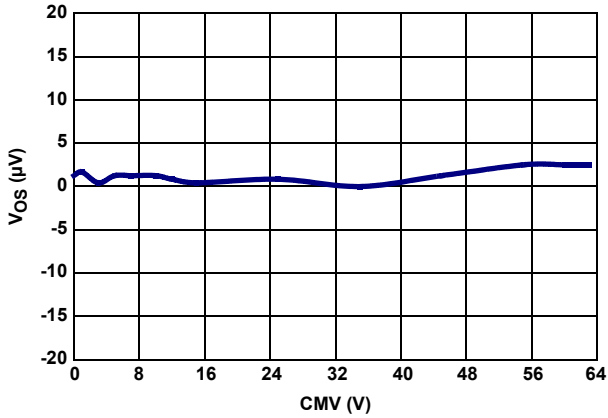

FIGURE 9. PRIMARY  $V_{SHUNT}$  CMRR vs CMV

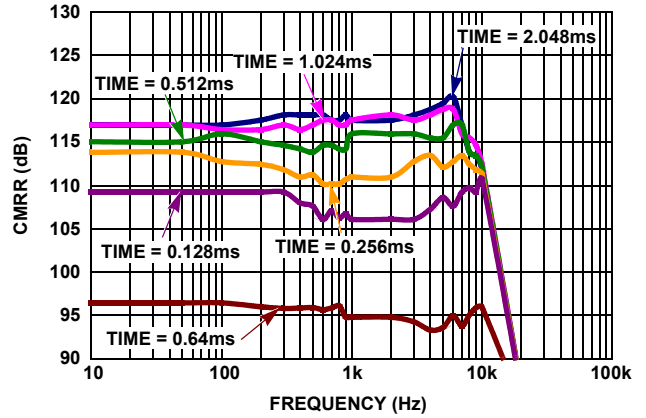

FIGURE 10. PRIMARY  $V_{SHUNT}$  AC CMRR vs FREQUENCY

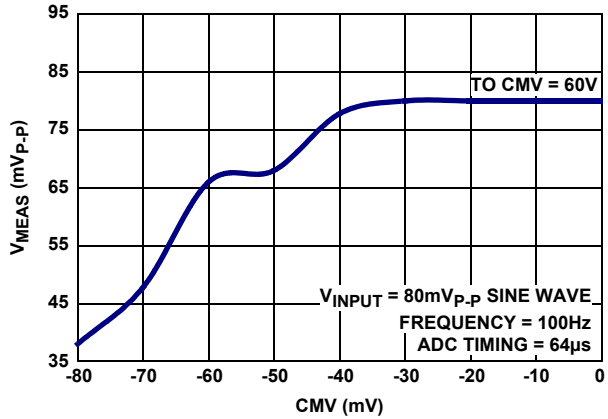

FIGURE 11. PRIMARY  $V_{SHUNT}$  COMMON MODE RANGE

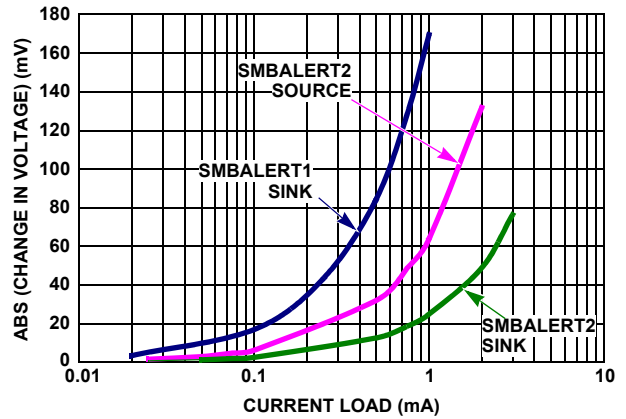

FIGURE 12. SMBALERT CURRENT DRIVES

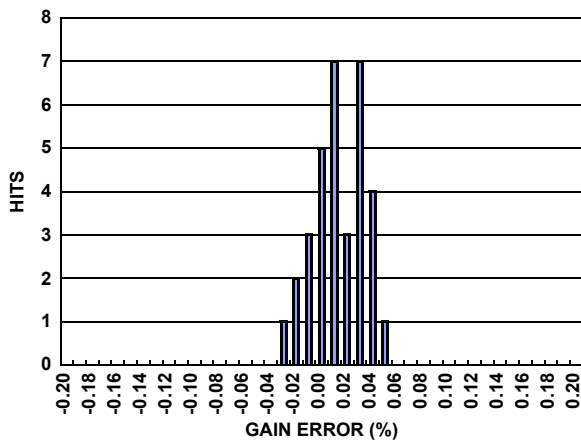

FIGURE 13. PRIMARY  $V_{SHUNT}$  ADC GAIN ERROR

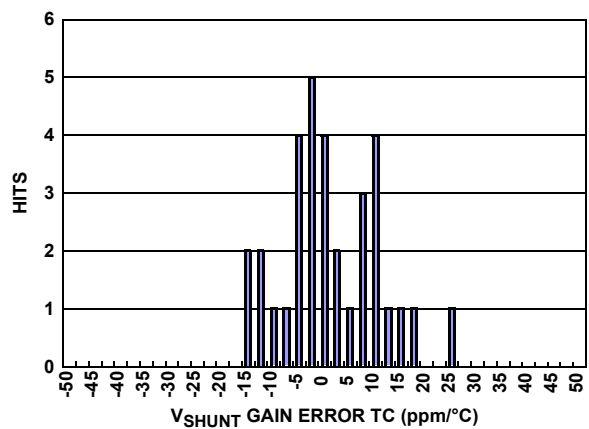

FIGURE 14. PRIMARY  $V_{SHUNT}$  ADC GAIN ERROR TC

## Typical Performance Curves $T_A = +25^\circ\text{C}$ , $V_{CC} = 3.3\text{V}$ , $V_{INP} = V_{BUS} = 12\text{V}$ , $Auxv = 3\text{V}$ , conversion time; $Aux = \text{Primary} = 2.05\text{ms}$ , Internal AVG $Aux = \text{Primary} = 128$ , unless otherwise specified. (Continued)

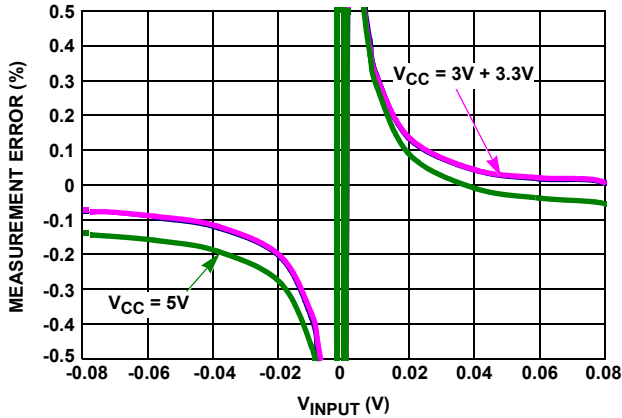

FIGURE 15. PRIMARY  $V_{SHUNT}$  MEASUREMENT ERROR vs INPUT

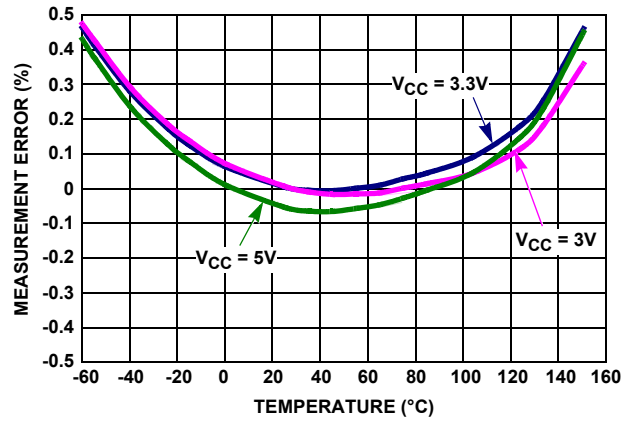

FIGURE 16. PRIMARY  $V_{SHUNT}$  MEASUREMENT ERROR vs TEMPERATURE

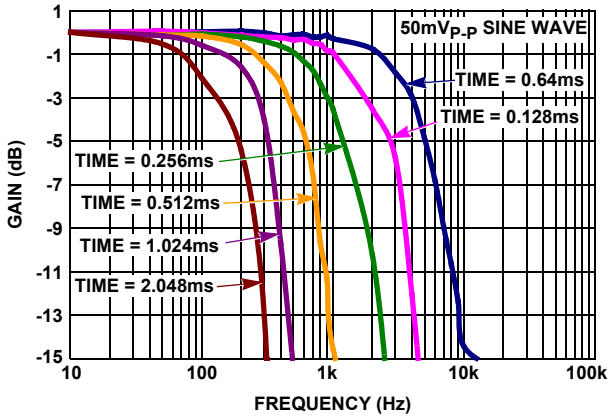

FIGURE 17. PRIMARY  $V_{SHUNT}$  BANDWIDTH vs ADC TIMING

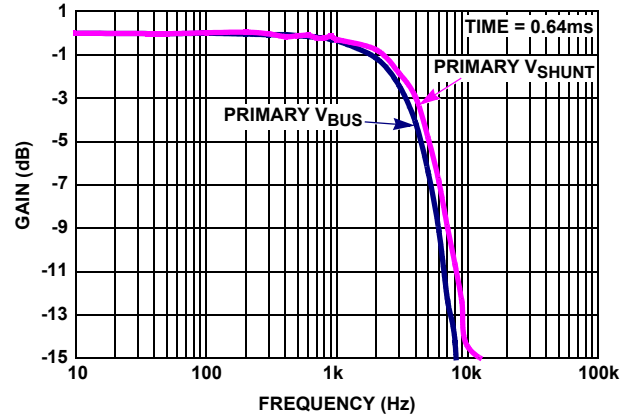

FIGURE 18. PRIMARY  $V_{SHUNT}$  AND  $V_{BUS}$  vs FREQUENCY

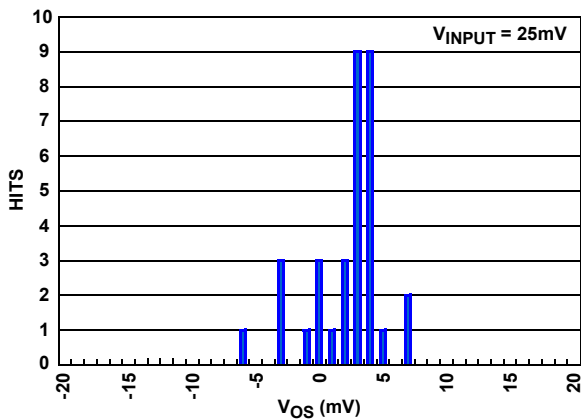

FIGURE 19. PRIMARY  $V_{BUS}$   $V_{OS}$

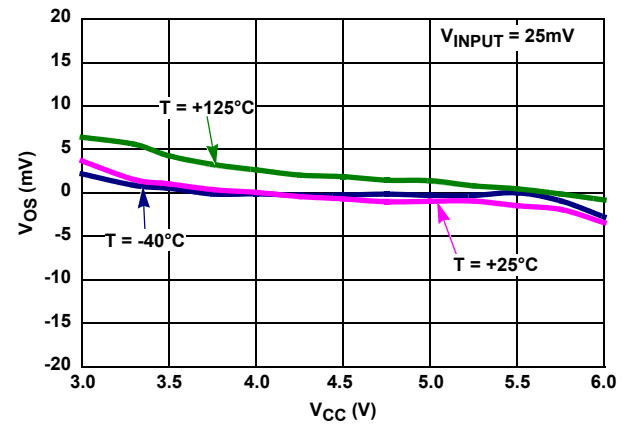

FIGURE 20. PRIMARY  $V_{BUS}$   $V_{OS}$  vs  $V_{CC}$

## Typical Performance Curves

$T_A = +25^\circ\text{C}$ ,  $V_{CC} = 3.3\text{V}$ ,  $V_{INP} = V_{BUS} = 12\text{V}$ ,  $Auxv = 3\text{V}$ , conversion time;  $Aux = Primary = 2.05\text{ms}$ , Internal AVG  $Aux = Primary = 128$ , unless otherwise specified. (Continued)

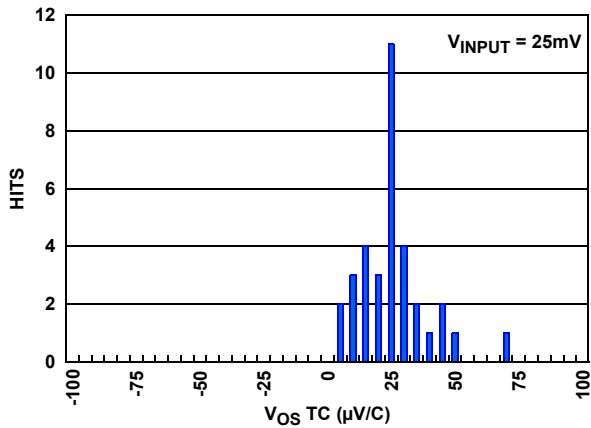

FIGURE 21. PRIMARY  $V_{BUS}$   $V_{OS}$  TC

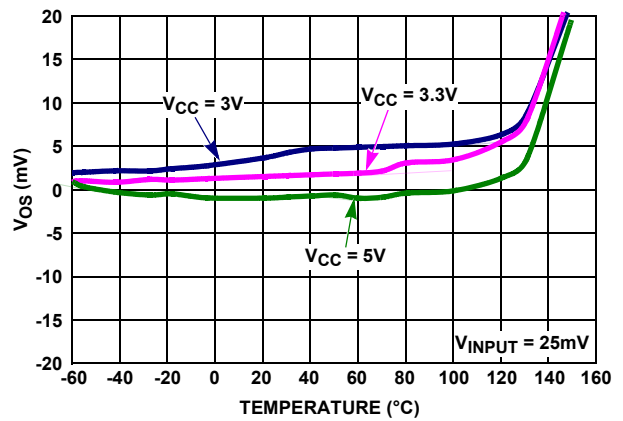

FIGURE 22. PRIMARY  $V_{BUS}$   $V_{OS}$  vs TEMPERATURE

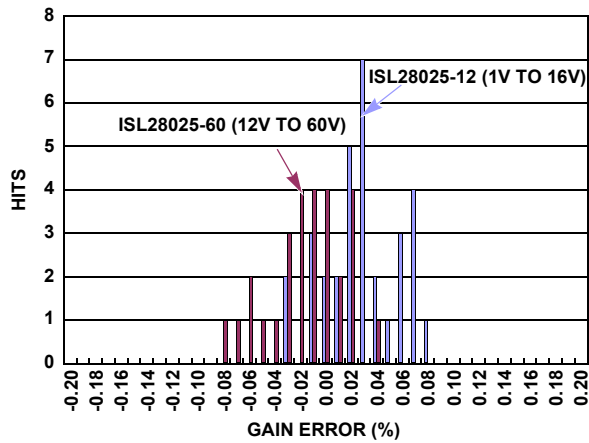

FIGURE 23. PRIMARY  $V_{BUS}$  ADC GAIN ERROR

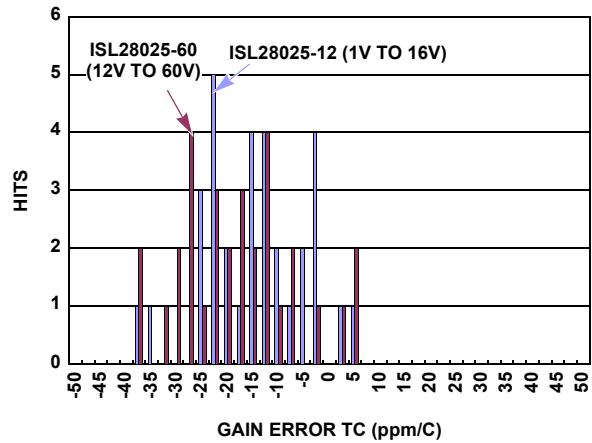

FIGURE 24. PRIMARY  $V_{BUS}$  ADC GAIN ERROR TC

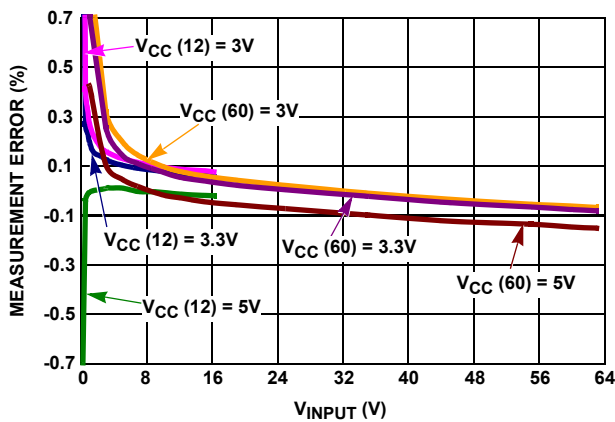

FIGURE 25. PRIMARY  $V_{BUS}$  MEASUREMENT ERROR vs INPUT

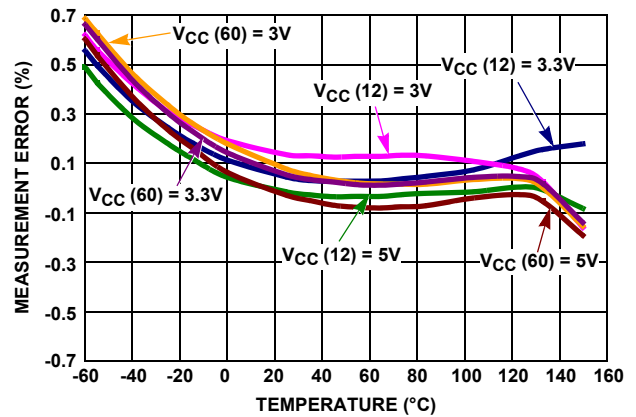

FIGURE 26. PRIMARY  $V_{BUS}$  MEASUREMENT ERROR vs TEMPERATURE

## Typical Performance Curves $T_A = +25^\circ\text{C}$ , $V_{CC} = 3.3\text{V}$ , $V_{INP} = V_{BUS} = 12\text{V}$ , $Auxv = 3\text{V}$ , conversion time; Aux = Primary = 2.05ms, Internal AVG Aux = Primary = 128, unless otherwise specified. (Continued)

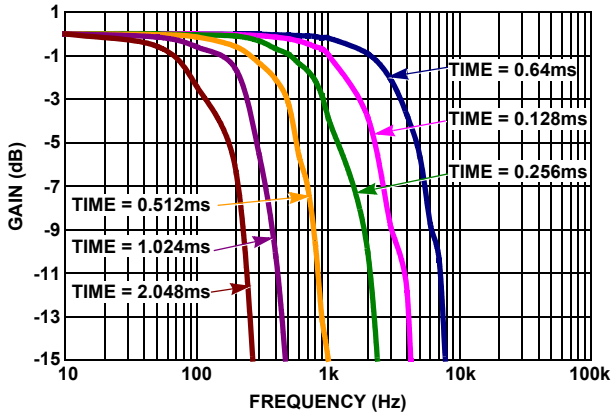

FIGURE 27. AUXILIARY  $V_{BUS}$  BANDWIDTH vs ADC TIMING

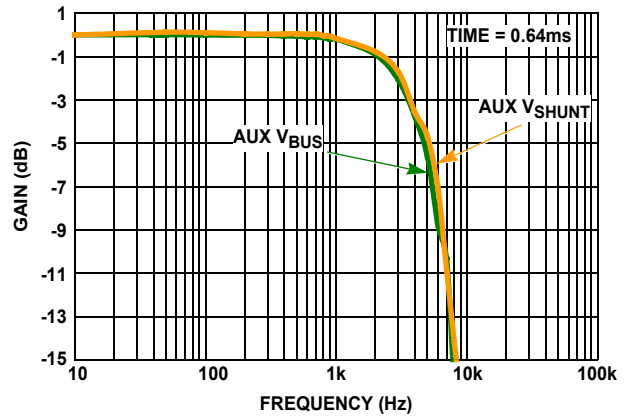

FIGURE 28. AUXILIARY  $V_{SHUNT}$  AND  $V_{BUS}$  vs FREQUENCY

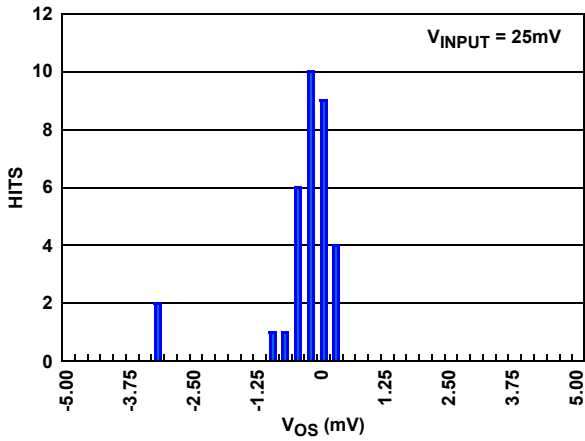

FIGURE 29. AUXILIARY  $V_{BUS}$   $V_{OS}$

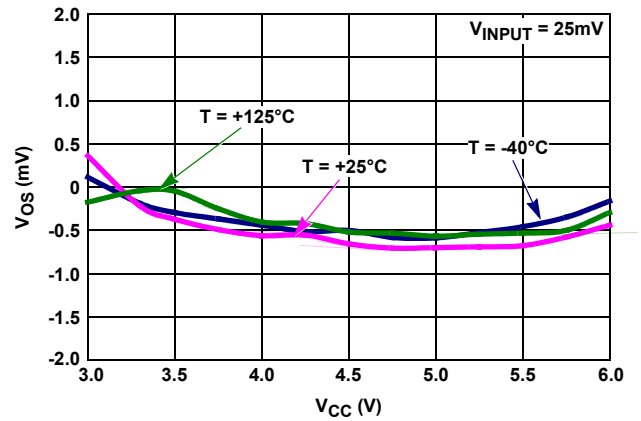

FIGURE 30. AUXILIARY  $V_{BUS}$   $V_{OS}$  vs  $V_{CC}$

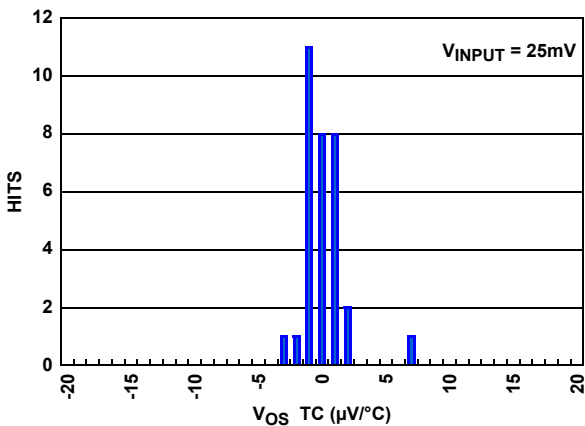

FIGURE 31. AUXILIARY  $V_{BUS}$   $V_{OS}$  TC

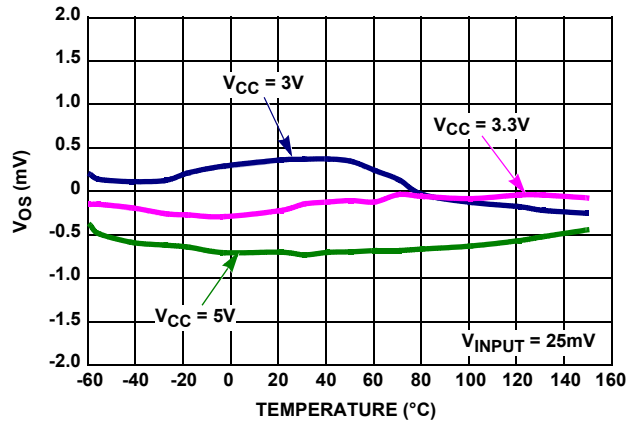

FIGURE 32. AUXILIARY  $V_{BUS}$   $V_{OS}$  vs TEMPERATURE

## Typical Performance Curves

$T_A = +25^\circ\text{C}$ ,  $V_{CC} = 3.3\text{V}$ ,  $V_{INP} = V_{BUS} = 12\text{V}$ ,  $Auxv = 3\text{V}$ , conversion time;   
 Aux = Primary = 2.05ms, Internal AVG Aux = Primary = 128, unless otherwise specified. (Continued)

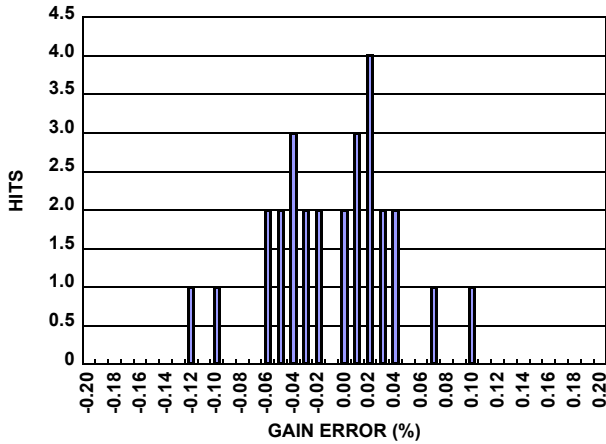

FIGURE 33. AUXILIARY  $V_{BUS}$  ADC GAIN ERROR

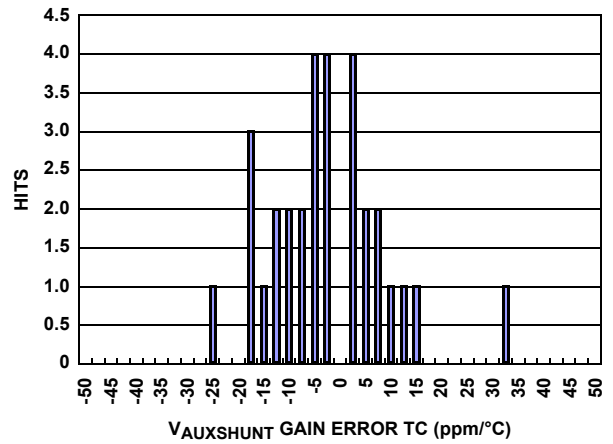

FIGURE 34. AUXILIARY  $V_{BUS}$  ADC GAIN ERROR TC

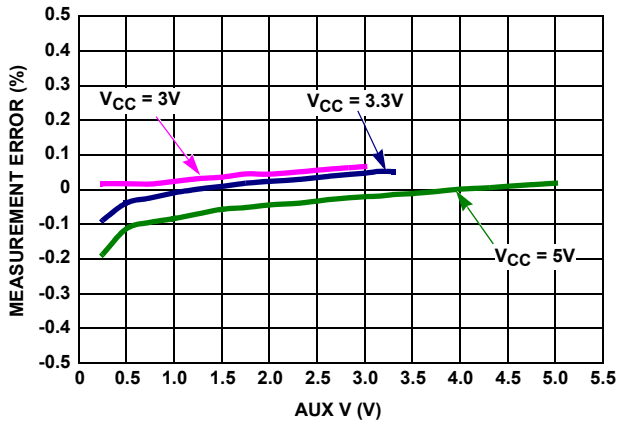

FIGURE 35. AUXILIARY  $V_{BUS}$  MEASUREMENT ERROR vs INPUT

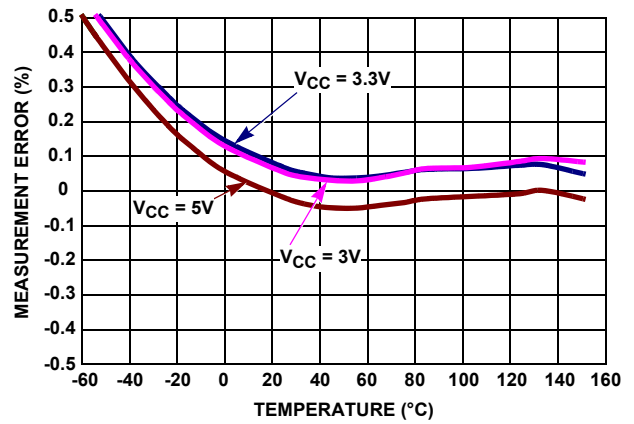

FIGURE 36. AUXILIARY  $V_{BUS}$  MEASUREMENT ERROR vs TEMPERATURE

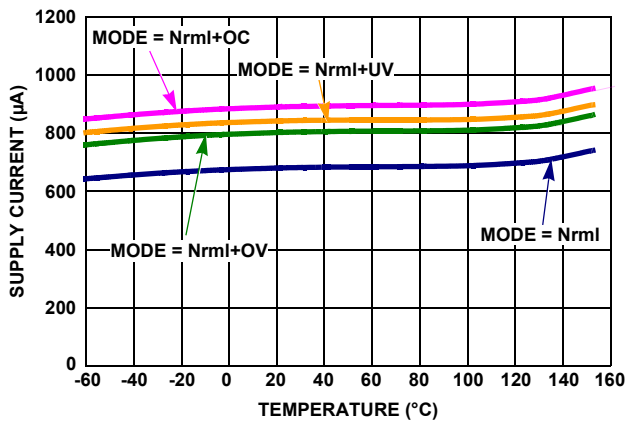

FIGURE 37. SUPPLY CURRENT vs TEMPERATURE

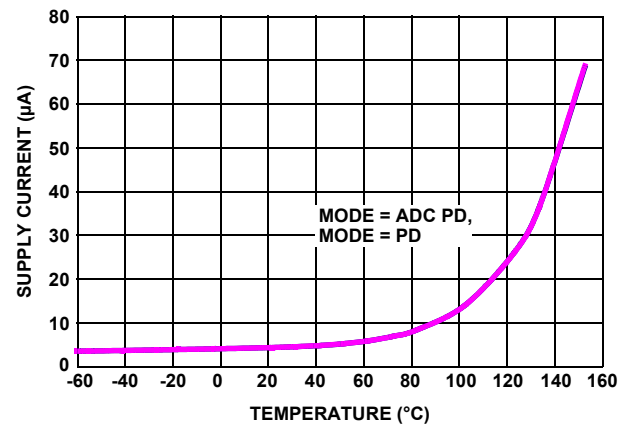

FIGURE 38. POWER-DOWN SUPPLY CURRENT vs TEMPERATURE



## Typical Performance Curves $T_A = +25^\circ\text{C}$ , $V_{CC} = 3.3\text{V}$ , $V_{INP} = V_{BUS} = 12\text{V}$ , $Auxv = 3\text{V}$ , conversion time; $Aux = \text{Primary} = 2.05\text{ms}$ , Internal AVG $Aux = \text{Primary} = 128$ , unless otherwise specified. (Continued)

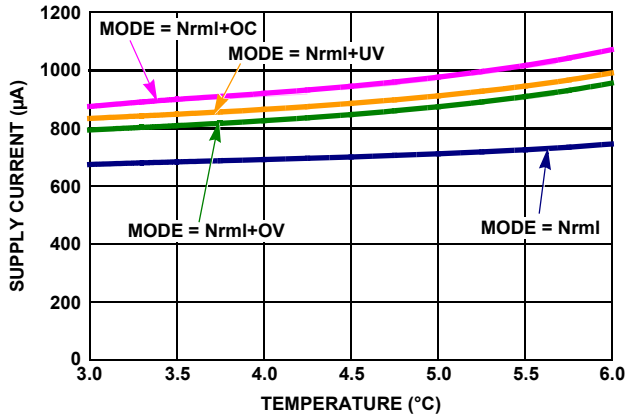

FIGURE 39. SUPPLY CURRENT vs SUPPLY VOLTAGE

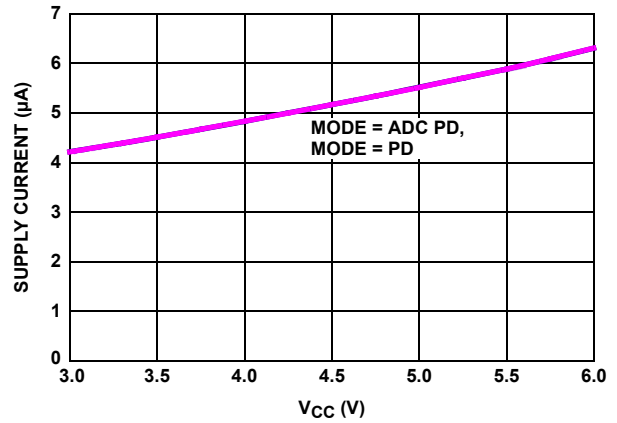

FIGURE 40. SUPPLY CURRENT vs SUPPLY VOLTAGE (POWER-DOWN MODES)

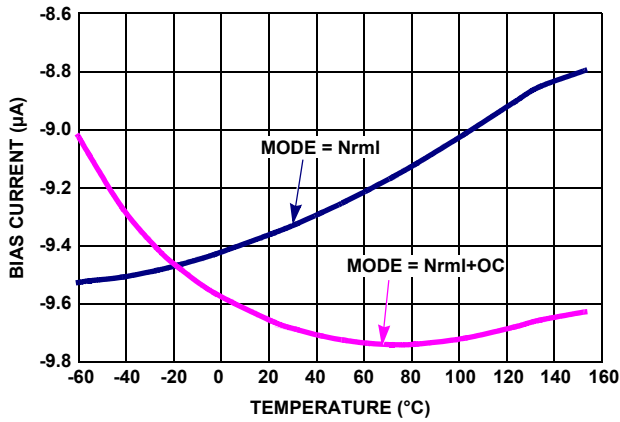

FIGURE 41. PRIMARY  $V_{SHUNT}$  BIAS CURRENT vs TEMPERATURE

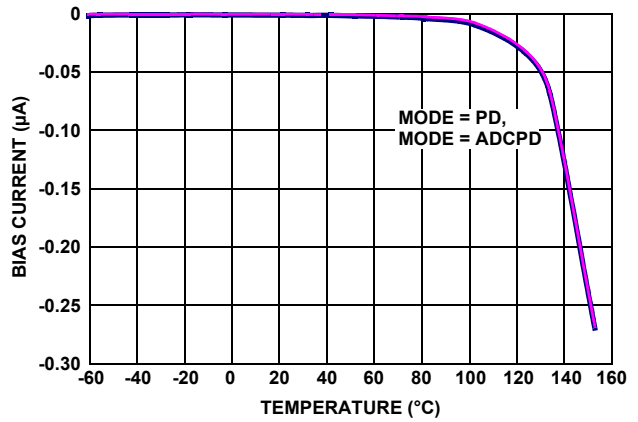

FIGURE 42. PRIMARY  $V_{SHUNT}$  BIAS CURRENT vs TEMPERATURE (POWER-DOWN MODE)

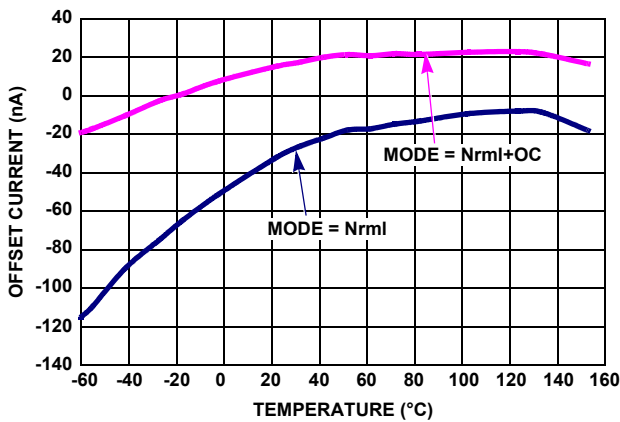

FIGURE 43. PRIMARY  $V_{SHUNT}$  BIAS CURRENT OFFSET vs TEMPERATURE

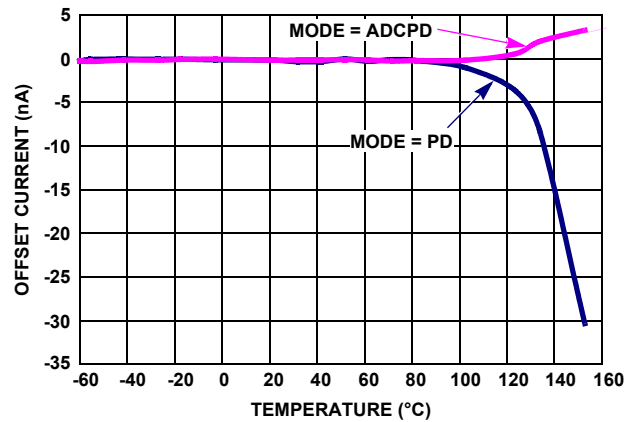

FIGURE 44. PRIMARY  $V_{SHUNT}$  BIAS CURRENT OFFSET vs TEMPERATURE (POWER-DOWN MODE)

## Typical Performance Curves $T_A = +25^\circ\text{C}$ , $V_{CC} = 3.3\text{V}$ , $V_{INP} = V_{BUS} = 12\text{V}$ , $Auxv = 3\text{V}$ , conversion time; $Aux = \text{Primary} = 2.05\text{ms}$ , Internal AVG $Aux = \text{Primary} = 128$ , unless otherwise specified. (Continued)

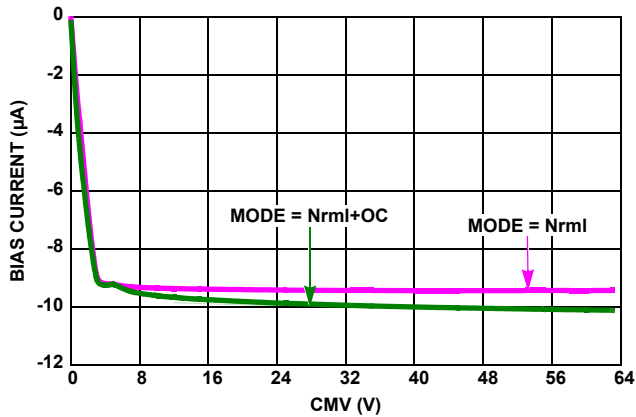

FIGURE 45. PRIMARY  $V_{SHUNT}$  BIAS CURRENT vs COMMON MODE VOLTAGE

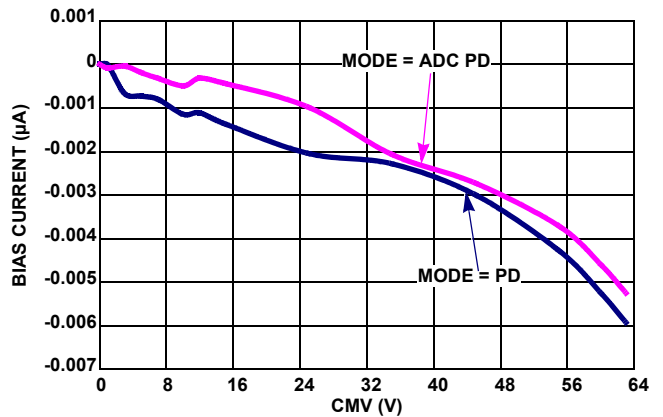

FIGURE 46. PRIMARY  $V_{SHUNT}$  BIAS CURRENT vs COMMON MODE VOLTAGE (POWER-DOWN MODES)

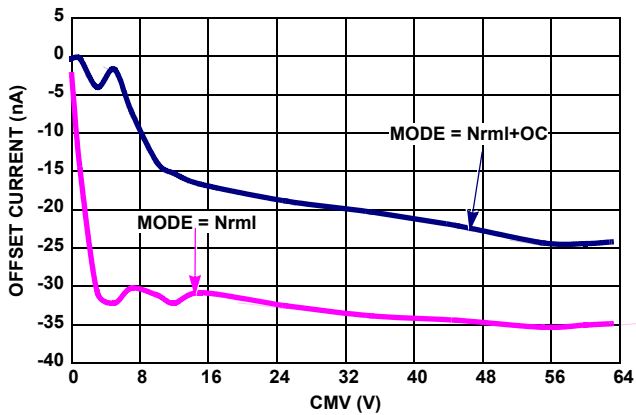

FIGURE 47. PRIMARY  $V_{SHUNT}$  OFFSET CURRENT vs COMMON MODE VOLTAGE

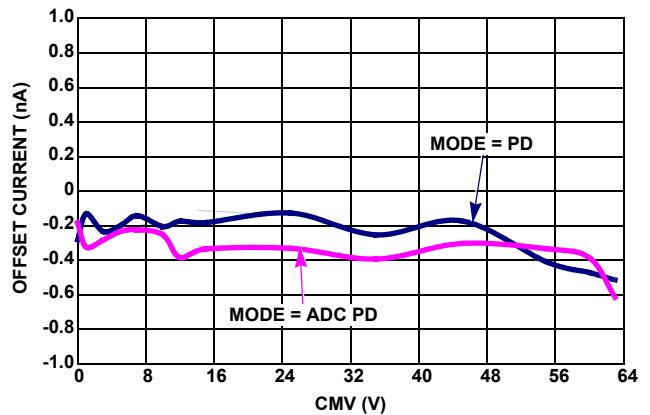

FIGURE 48. PRIMARY  $V_{SHUNT}$  OFFSET CURRENT vs COMMON MODE VOLTAGE (POWER DOWN MODES)

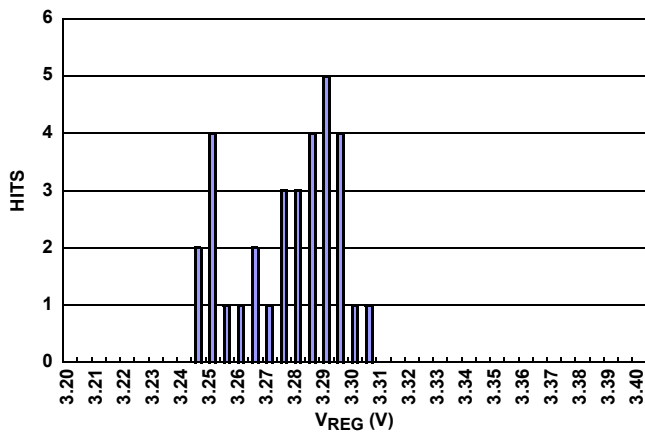

FIGURE 49.  $V_{REG}$  OUTPUT VOLTAGE DISTRIBUTION

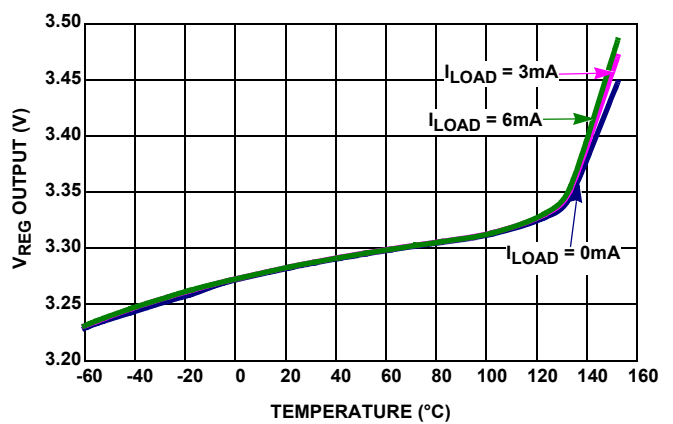

FIGURE 50.  $V_{REG}$  OUTPUT vs TEMPERATURE

## Typical Performance Curves

$T_A = +25^\circ\text{C}$ ,  $V_{CC} = 3.3\text{V}$ ,  $V_{INP} = V_{BUS} = 12\text{V}$ ,  $Auxv = 3\text{V}$ , conversion time;  $Aux = Primary = 2.05\text{ms}$ , Internal AVG  $Aux = Primary = 128$ , unless otherwise specified. (Continued)

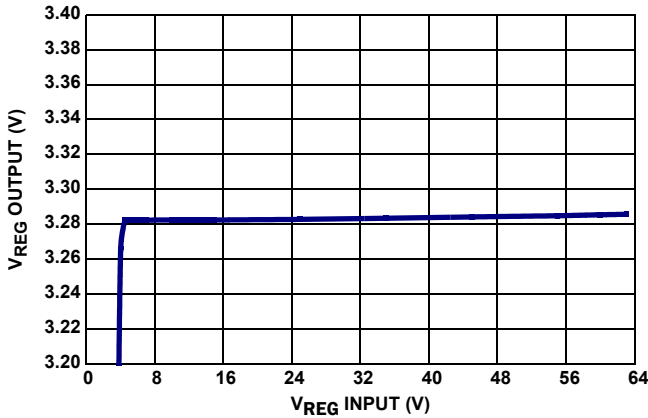

FIGURE 51.  $V_{REG}$  OUTPUT vs INPUT VOLTAGE

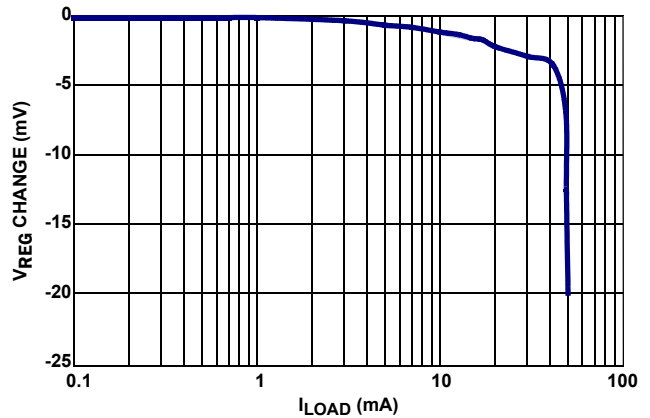

FIGURE 52.  $V_{REG}$  OUTPUT vs CURRENT LOAD

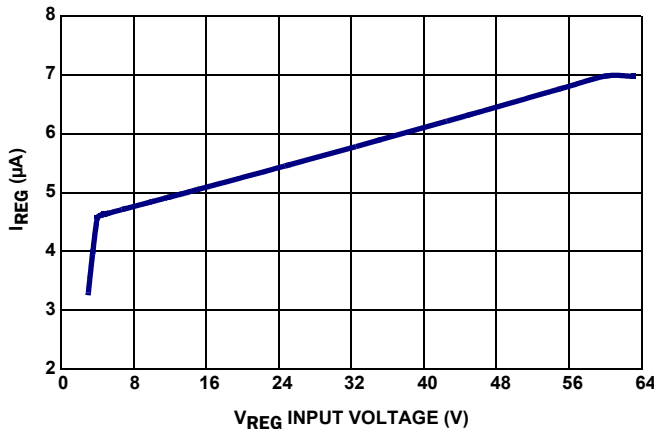

FIGURE 53.  $V_{REG}$  INPUT CURRENT vs INPUT VOLTAGE

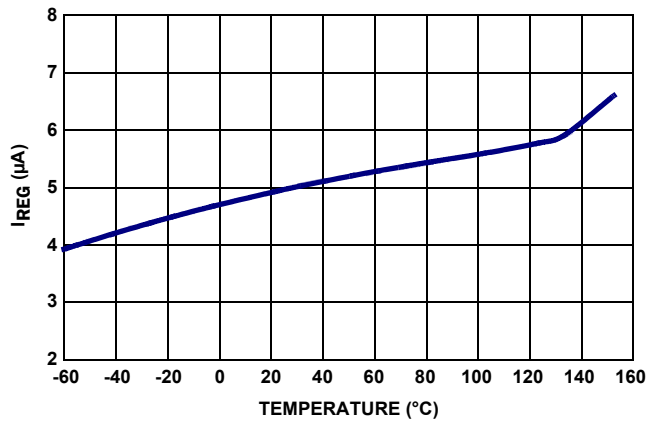

FIGURE 54.  $V_{REG}$  INPUT CURRENT vs TEMPERATURE

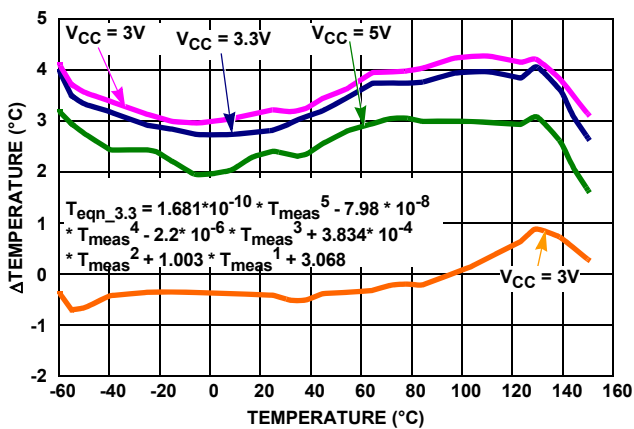

FIGURE 55. INTERNAL TEMPERATURE SENSOR ACCURACY

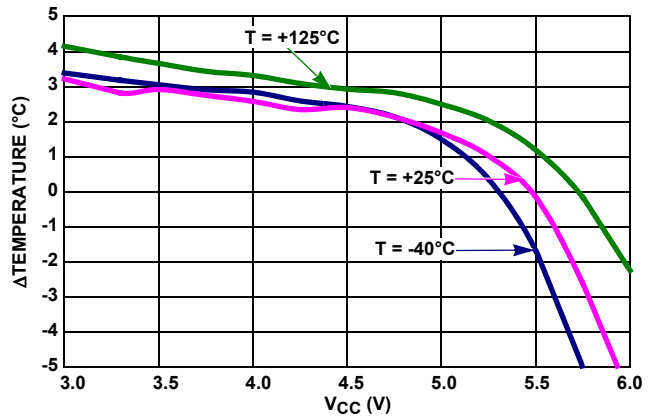

FIGURE 56. INTERNAL TEMPERATURE ACCURACY vs  $V_{CC}$

## Typical Performance Curves

$T_A = +25^\circ\text{C}$ ,  $V_{CC} = 3.3\text{V}$ ,  $V_{INP} = V_{BUS} = 12\text{V}$ ,  $Auxv = 3\text{V}$ , conversion time;   
 Aux = Primary = 2.05ms, Internal AVG Aux = Primary = 128, unless otherwise specified. (Continued)

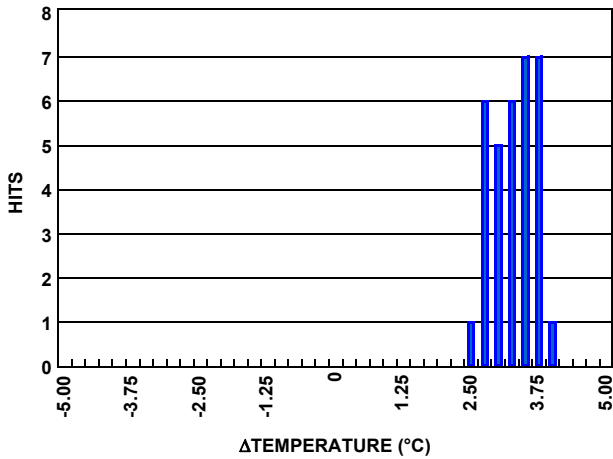

FIGURE 57. INTERNAL TEMPERATURE ACCURACY AT T = +25°C

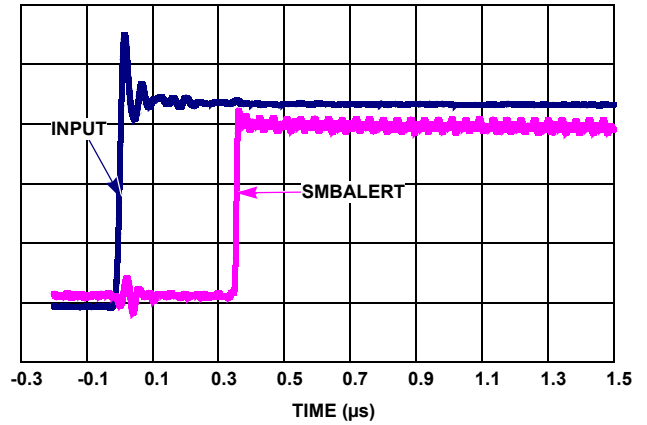

FIGURE 58. OV OR UV OR OC ALERT RESPONSE TIME

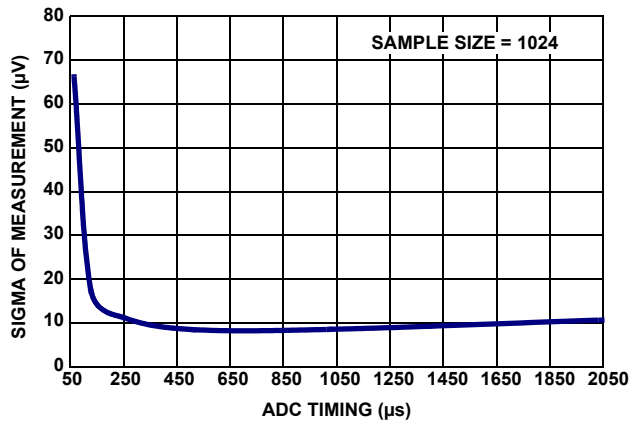

FIGURE 59. PRIMARY SHUNT STABILITY: STDEV vs ACQUISITION TIME

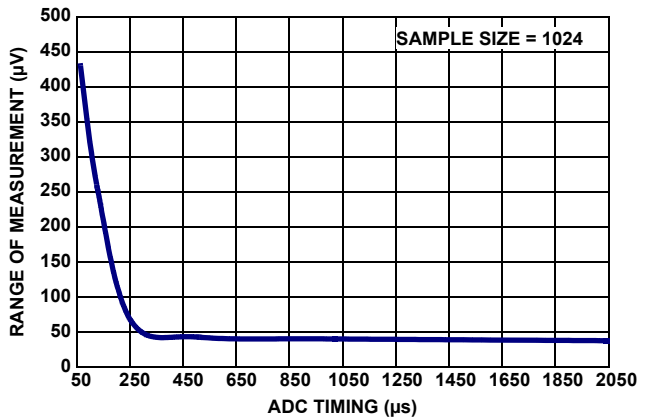

FIGURE 60. PRIMARY SHUNT STABILITY: RANGE vs ACQUISITION TIME

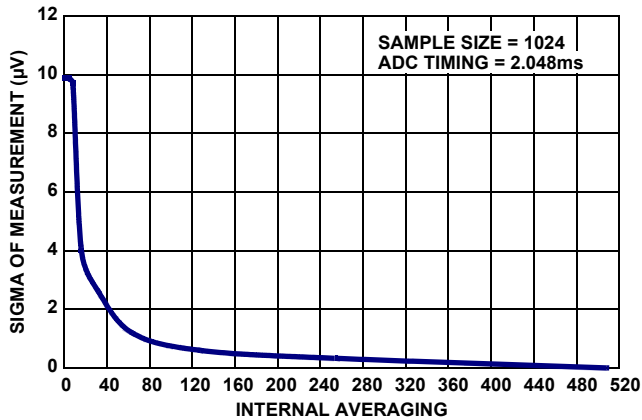

FIGURE 61. PRIMARY SHUNT STABILITY: STDEV vs INTERNAL AVERAGING

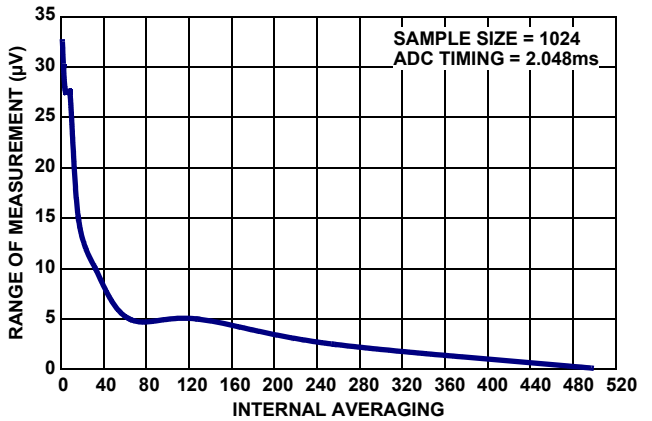

FIGURE 62. PRIMARY SHUNT STABILITY: RANGE vs INTERNAL AVERAGING

## Functional Description

### Overview

The ISL28025 is a digital current, voltage and power monitoring device for high and low side power monitoring in positive and negative voltage applications.

The digital power monitor (DPM) requires an external shunt resistor to enable current measurements. The shunt resistor translates the bus current to a voltage. The DPM measures the voltage across the shunt resistors and reports the measured value out digitally via an I<sup>2</sup>C interface. A register within the DPM is reserved to store the value of the shunt resistor. The stored current sense resistor value allows the DPM to output a current value to an external digital device.

The ISL28025 can monitor the voltage, current and power of a power supply rail. The ISL28025 has an additional low voltage read to measure a voltage after the rail has been regulated. The primary channel will allow and measure voltages from 0V to 60V or from 0V to 16.384V, depending on the option of the ISL28025. The auxiliary channel can tolerate and measure voltage from 0V to VCC.

The ISL28025 has continuous fault detection for the primary channel. The DPM can be configured to set an alert in the instance of an overvoltage, undervoltage and/or overcurrent event. The response time of the alert is 500ns from the event. The ISL28025 has a temperature sensor with fault detection.

An 8-bit margin DAC, controllable through I<sup>2</sup>C communication, is incorporated into the DPM. The voltage margining feature allows for the adjustment of the regulated voltage to the load. The margin DAC can help in proving the load robustness versus the applied supply voltage.

The ISL28025 offers a 3.3V voltage regulator that can be used to power the chip in addition to low power peripheral circuitry. The DPM has an I<sup>2</sup>C power pin that allows the I<sup>2</sup>C master to set the digital communication supply voltage to the chip. The operating supply voltage for the DPM ranges from 3V to 5.5V. The device will accept I<sup>2</sup>C supply voltages between 1.2V and 5.5V.

The ISL28025 accepts SMBus protocols up to 3.4MHz. The device is PMBus compliant up to 400MHz. The device has packet error code (PEC) functionality. The PEC protocol uses an 8-bit cyclic redundancy check (CRC-8) represented by the polynomial  $x^8+x^2+x^1+1$ . The ISL28025 can be configured for up to 55 unique slave addresses using 3 address select bits. The large amount of addressing allows 55 parts to communicate on a single I<sup>2</sup>C bus. It also gives the designer the flexibility to select a unique address when another slave address conflicts with the DPM on the same I<sup>2</sup>C bus.

### Functional Pin Descriptions

#### VBUS

VBUS is the power bus voltage input pin. The pin should be connected to the desired power supply bus to be monitored. The voltage range for the pin is from 0V to 60V or 0V to 16V depending on the ISL28025 version.

#### VINP

VINP is the shunt voltage monitor positive input pin. The pin connects to the most positive voltage of the current shunt resistor. The voltage range for the pin is from 0V to 60V or 0V to 16V depending on the ISL28025 version. The maximum measurable voltage differential between VINP and VINM is 80mV.

#### VINM

VINM is the shunt voltage monitor negative input pin. The pin connects to the most negative voltage of the current shunt resistor. The voltage range for the pin is from 0V to 60V or 0V to 16V depending on the ISL28025 version. The maximum measurable voltage differential between VINP and VINM is 80mV.

#### AUXV

AUXV is the power bus voltage input pin. The pin should be connected to the desired power supply bus to be monitored. The voltage range for the pin is from 0V to VCC.

#### VCC

VCC is the positive supply voltage pin. VCC is an analog power pin. VCC supplies power to the device. The allowable voltage range is from 3V to 5.5V.

#### I2CVCC

I2CVCC is the positive supply voltage pin. I2CVCC is an analog power pin. I2CVCC supplies power to the digital communication circuitry, I<sup>2</sup>C, of the device. The allowable voltage range is from 1.2V to 5.5V.

#### GND

GND is the device ground pin. For single supply systems, the pin connects to system ground. For dual supply systems, the pin connects to the negative voltage supply in the system.

#### VREG\_IN

VREG\_IN is the voltage regulator input pin. The operable input voltage range to the regulator is 4.5V to 60V.

#### VREG\_OUT

VREG\_OUT is the voltage regulator output pin. The regulated output voltage of 3.3V is sourced from the VREG\_OUT pin.

#### ADDRESS PINS (A0, A1, A2)

A0, A1 and A2 are address selectable pins. The address pins are I<sup>2</sup>C/SMBus slave address select pins that are multilogic programmable for a total of 55 different address combinations.

There are four selectable levels for the address pins, I2CVCC, GND, SCL/SMBCLK and SDA/SMBDAT. See [Table 45](#) for more details in setting the slave address of the device.

#### SMBDAT

SDA/SMBDAT is the serial data input/output pin. SDA/SMBDAT is a bidirectional pin used to transfer data to and from the device. The pin is an open-drain output and may be wired with other open-drain/collector outputs. The input buffer is always active (not gated). The open-drain output requires a pull-up resistor for proper functionality. The pull-up resistor should be connected to I2CVCC of the device.

# ISL28025

## SMBCLK

SCL/SMBCLK is the serial clock input pin. The SCL/SMBCLK input is responsible for clocking in all data to and from the device. The input buffer on the pin is always active (not gated). The input pin requires a pull-up resistor to I2CVCC of the device.

## SMBALERT PINS (SMBALERT1, SMBALERT2)

The SMBALERT pins are output pins. The SMBALERT1 is an open-drain output and requires a pull-up resistor to a power supply up to 24V. The SMBALERT2 has a push/pull output stage.

The SMBALERT pins are fault acknowledgment pins. The pin can be connected to peripheral circuitry to halt operations when a fault event occurs.

## ECLK

ECLK is the External clock pin. ECLK is an input pin. The pin provides a connection to the system clock. The system clock is connected to the ADC. The acquisitions rate of the ADC can be varied through the ECLK pin. The pin functionality is set through a control register bit.

TABLE 2. ISL28025 REGISTER DESCRIPTIONS

REGISTER ADDRESS (HEX)	REGISTER NAME	FUNCTION	POWER ON RESET VALUE (HEX)	NUMBER OF BYTES	ACCESS TYPE	PAGE
<b>IC DEVICE DETAILS</b>						
19	CAPABILITY	PMBus Supportability	B0	1	R	<a href="#">24</a>
20	VOUT_MODE	Describes the ADC Read Back Format	40	1	R	<a href="#">24</a>
99	PMBUS_REV	PMBus Revision	22	1	R	<a href="#">24</a>
AD	IC_DEVICE_ID	Device ID	49534C3238303235	8	R	<a href="#">25</a>
AE	IC_DEVICE_REV	Device Revision and Silicon Version	000002	3	R	<a href="#">25</a>
<b>GLOBAL IC CONTROLS</b>						
12	RESTORE_DEFAULT_ALL	Soft Reset	N/A	0	W	<a href="#">25</a>
01	OPERATION	Turns the Device On and Off	80	1	R/W	<a href="#">25</a>
<b>PRIMARY AND AUXILIARY CHANNEL CONTROLS</b>						
D2	SET_DPM_MODE	Configures the ISL28025	0A	1	R/W	<a href="#">25</a>
D3	DPM_CONV_STATUS	Indicates the Status of a Conversion	N/A	1	R	<a href="#">26</a>
D4	CONFIG_ICHANNEL	Shunt Inputs (Primary and Auxiliary) Configuration	0387	2	R/W	<a href="#">26</a>
38	IOUT_CAL_GAIN	Calibration that Enables Primary Current Measurements	0000	2	R/W	<a href="#">27</a>
D5	CONFIG_VCHANNEL	Bus Inputs (Primary and Auxiliary) Configuration	0387	2	R/W	<a href="#">27</a>
D7	CONFIG_PEAK_DET	Enables Primary Channel Current Peak Detector	00	1	R/W	<a href="#">28</a>
<b>MEASUREMENT REGISTERS</b>						
D6	READ_VSHUNT_OUT	Primary Shunt Measurement Value	0000	2	R	<a href="#">28</a>
8B	READ_VOUT	Primary Bus Measurement Value	0000	2	R	<a href="#">28</a>
8C	READ_IOUT	Primary Current Measurement Value	0000	2	R	<a href="#">28</a>
D8	READ_PEAK_MIN_IOUT	Primary Current Max Measurement Value	7FFF	2	R	<a href="#">28</a>
D9	READ_PEAK_MAX_IOUT	Primary Current Min Measurement Value	8001	2	R	<a href="#">28</a>
96	READ_POUT	Primary Power Measurement Value	0000	2	R	<a href="#">28</a>
E1	READ_VOUT_AUX	Auxiliary Bus Measurement Value	0000	2	R	<a href="#">28</a>
8D	READ_TEMPERATURE_1	Internal Temperature Measurement Value	0000	2	R	<a href="#">29</a>
<b>THRESHOLD DETECTORS</b>						
DA	VOUT_OV_THRESHOLD_SET	Overvoltage/Over-temperature Threshold Configuration	003F	2	R/W	<a href="#">29</a>
DB	VOUT_UV_THRESHOLD_SET	Undervoltage Threshold Configuration	00	1	R/W	<a href="#">30</a>
DC	IOUT_OC_THRESHOLD_SET	Overcurrent Threshold Configuration	003F	2	R/W	<a href="#">30</a>

# ISL28025

TABLE 2. ISL28025 REGISTER DESCRIPTIONS (Continued)

REGISTER ADDRESS (HEX)	REGISTER NAME	FUNCTION	POWER ON RESET VALUE (HEX)	NUMBER OF BYTES	ACCESS TYPE	PAGE
<b>SMB ALERT</b>						
DD	CONFIG_INTR	Configure the Behavior of the Interrupts	0000	2	R/W	<a href="#">32</a>
DE	FORCE_FEEDTHR_ALERT	Configure the Path of the Interrupt Signal	00	1	R/W	<a href="#">33</a>
1B	SMBALERT_MASK	Alert Mask for the SMBALERT1 Pin	N/A	2	R/W	<a href="#">35</a>
DF	SMBALERT2_MASK	Alert Mask for the SMBALERT2 Pin	N/A	1	R/W	<a href="#">35</a>
03	CLEAR_FAULTS	Clears All Faults	N/A	0	W	<a href="#">33</a>
7A	STATUS_VOUT	Alert Bits Related to the Primary Bus	00	1	R/W	<a href="#">33</a>
7B	STATUS_IOUT	Alert Bit Related to the Primary Shunt	00	1	R/W	<a href="#">33</a>
7D	STATUS_TEMPERATURE	Alert Bit Related to Temperature	00	1	R/W	<a href="#">33</a>
7E	STATUS_CML	Alert Bits Related to Communication Errors	00	1	R/W	<a href="#">34</a>
78	STATUS_BYTE	Alert Bits Related to Temperature and Device Status	00	1	R/W	<a href="#">34</a>
79	STATUS_WORD	Alert Bits Related to all Primary Inputs	0000	2	R/W	<a href="#">34</a>
<b>EXTERNAL CLOCK CONTROL</b>						
E5	CONFIG_EXT_CLK	Configures External Clock; Enable/Disable SMBALERT2	00	1	R/W	<a href="#">35</a>

## Communication Protocol

The DPM chip communicates with the host using PMBus commands. PMBus command structure is an industry SMBus standard for communicating with power supplies and converters. All communications to and from the chip use the SMBCLK and SMBDAT to communicate to the DPM master. The SMB pins require a pull-up resistor to enable proper operation. The default logic state of the communication pins are high when the bus is in an idle state.

The SMBus standard is a variant of the I<sup>2</sup>C communication standard with minor differences with timing and DC parameters. SMBus supports packet error corrections (PEC) for data integrity certainty. The PMBus is the standardization of the SMBus register designation. The standardization is specific to power and converter devices.

The DPM employs the following command structures from the I<sup>2</sup>C communication standard.

1. Send Byte
2. Write Byte/Word
3. Read Byte/Word
4. Read Block
5. Write Block

### Packet Error Correction (PEC)

Packet Error correction is often used in environments where data being transferred to and from the device can be compromised. Applications where the device is connected by way of a cable is common use of PEC. The cable's integrity may be compromised resulting in error transactions between the master and the device. The ISL28025 uses an 8-bit cyclic redundancy check (CRC-8). Following is an example of a flow algorithm for CRC-8 protocol.

### Public Function `crc8Decode(binStr As String) As Byte`

Dim `crc8(0 To 7)` As Byte, `index` As Byte, `doInvert` As Byte

*The input to the subroutine is a binary string consisting of the slave address, the register address and data inputted to or received from the part. Anything inputted into or received from the device is part of the binary string (binStr) to be calculated by this routine.*

*Clear the `crc8` variable. This variable is used to return the PEC value.*

For `index = 0` To `UBound(crc8)`

`crc8(index) = 0`

Next `index`

`index = 0`

While `index <> (Len(binStr))`

`index = index + 1`

*The If statement below reads the binary value of each bit in the binary string (binStr).*

If `Mid(binStr, index, 1) = "1"` Then

`doInvert = 1 Xor crc8(7)`

Else

`doInvert = 0 Xor crc8(7)`

End If

`crc8(7) = crc8(6)`

`crc8(6) = crc8(5)`

`crc8(5) = crc8(4)`

`crc8(4) = crc8(3)`

`crc8(3) = crc8(2)`

`crc8(2) = crc8(1) Xor doInvert`

`crc8(1) = crc8(0) Xor doInvert`

`crc8(0) = doInvert`

Wend

`crc8Decode = 0`

For `index = 0` To `7` *This assembles the `crc8` value in byte form.*

`crc8Decode = crc8(index) * 2 ^ index + crc8Decode`

Next `index` *'`crc8Decode` is returned from this routine.*

End Function

**FIGURE 63. ALGORITHM TO CALCULATE A CRC8 (PEC) BYTE VALUE**

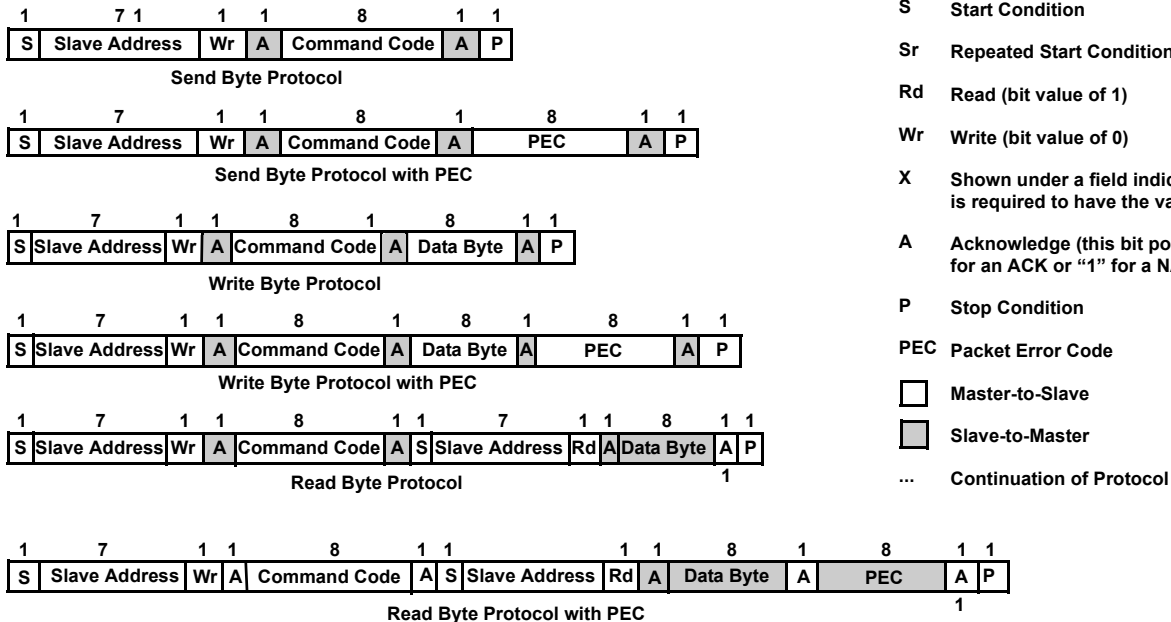

FIGURE 64. READ/WRITE SMBus PROTOCOLS WITH AND WITHOUT PEC

NOTE: Diagrams copied from a SMBus specification document. The document can be uploaded at <http://smbus.org/specs/>

## IC Device Details

### 0X19 CAPABILITY (R)

The capability register is a read only byte register that describes the supporting communication standard by the DPM chip.

TABLE 3. 0x19 CAPABILITY REGISTER DEFINITION

BIT NUMBER	D7	D[6:5]	D4	D[3:0]
Bit Name	PEC	Max Bus Speed	SMB Alert Support	N/A
Default Value	1	01	1	0000

The DPM chip supports packet error correction (PEC) protocol. The maximum PMBus bus speed that the DPM supports is 400kHz. The DPM supports a higher speed option that is not compliant to the PMBus standard. The higher speed option is discussed later in the datasheet. The DPM chip has SMB alert pins, which supports SMB alert commands.

### 0X20 V<sub>OUT</sub> MODE (R)

The V<sub>OUT</sub> Mode register is a readable byte register that describes the method to calculate read back values from the DPM such as voltage, current, power and temperature. The value for the register is 0x40. The register value represents a direct data read back format. For unsigned registers such as V<sub>BUS</sub>, the register value is calculated using [Equation 1](#).

$$\text{Register Value} = \left[ \sum_{n=0}^{15} \left( \text{Bit\_Val}_n \cdot 2^n \right) \right] \quad (\text{EQ. 1})$$

Otherwise, [Equation 2](#) is used for signed readings.

$$\text{Register Value} = \left[ \sum_{n=0}^{14} \left( \text{Bit\_Val}_n \cdot 2^n \right) \right] - \left( \text{Bit\_Val}_{15} \cdot 2^{15} \right) \quad (\text{EQ. 2})$$

n is the bit position within the register value. Bit\_Val is the value of the bit either 1 or 0.

### 0X99 PMBUS REV (R)

The PMBUS Rev register is a readable byte register that describes the PMBUS revision that the DPM is compliant to.

TABLE 4. 0x99 PMBUS REV REGISTER DEFINITION

BIT NUMBER	D[7:4]	D[3:0]
Bit Name	PMBUS Rev Part I	PMBUS Rev Part II
Default Value	0010	0010

PMBUS Rev part 1 is a PMBus specification pertaining to electrical transactions and hardware interface. PMBUS Rev part 2 specification pertains to the command calls used to address the DPM.

A nibble of 0000 translates to revision 1.0 of either PMBUS revision. A nibble of 0001 equals 1.1 of either PMBus revision.



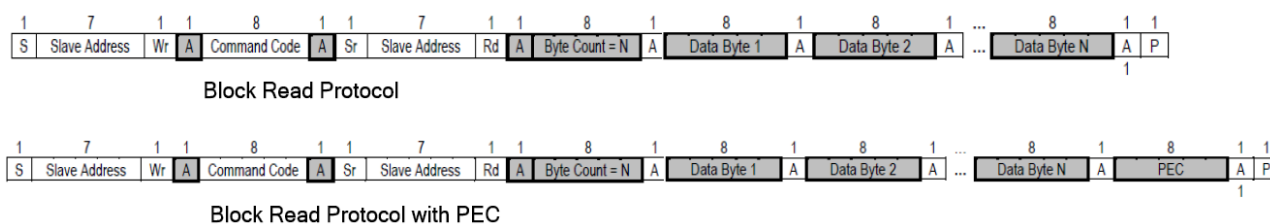

FIGURE 65. BLOCK READ SMBUS PROTOCOLS WITH AND WITHOUT PEC.

NOTE: Diagrams copied from SMBus specification document. The document can be uploaded at <http://smbus.org/specs/>

## 0XAD IC DEVICE ID (BR)

The IC Device ID is a block readable register that reports the device product name being addressed. The product ID that is stored in the register is “ISL28025”. Each character is stored as an ASCII number. A 0x30 equals ASCII “0”. A 0x49 translates to an ASCII “I”. Figure 65 illustrates the convention for performing a block read.

## 0XAE IC\_DEVICE\_REV (BR)

The IC Device Revision is a block readable register that reports back the revision number of the silicon and the version of the silicon. The register is 3 bytes in length.

TABLE 5. 0xAE IC DEVICE REV REGISTER DEFINITION

BIT NUMBER	D[23:12]	D[11]	D[10:0]
Bit Name	N/A	Silicon Version	Silicon Revision
Default Value	0000 0011 0000	0	0000 0000 0010

## SILICON VERSION D[11]

Data bit 11 of the IC Revision register reports the version of the silicon.

TABLE 6. D[11] SILICON VERSION BIT DEFINED

D4	STATUS
0	60V
1	12V

## Global IC Controls

### 0X12 RESET DEFAULT ALL (S)

The Restore Default All register is a send byte command that restores all registers to the default state defined in Table 2 on page 22.

### 0X01 OPERATION (R/W)

The Operation register is a read/writable byte register that controls the overall power-up state of the chip. Data Bit 7 of the register configures the power status of chip. The power status is defined in Table 7. Yellow shading in the table is the default setting of the bit at power-up.

TABLE 7. 0x01 OPERATION REGISTER BIT 7 DEFINED

D7	STATUS
0	Power-down
1	Normal Operation

## Primary and Auxiliary Channel Controls

### 0XD2 SET DPM MODE (R/W)

The Set DPM Mode is a read/writable byte register that controls the data acquisition behavior of the chip.

TABLE 8. 0xD2 SET DPM MODE REGISTER DEFINITION

BIT NUMBER	D[7]	D6	D[5]	D[4]	D[3]	D[2:0]
Bit Name	N/A	ADC Enable	ADC State	Post Trigger State	ADC Mode Type	Operating Mode
Default Value	0	0	0	0	1	010

### ADC ENABLE D[6]

Data Bit 6 of the Set DPM Mode register controls the ADC power state within the DPM chip. At power-up, the ADC is powered up and is available to take data.

TABLE 9. 0xD2 SET DPM MODE REGISTER BIT 6 DEFINED

D6	ADC PD
0	Normal Mode
1	ADC Powered Down

### ADC STATE D[5]

Data Bit 5 of the Set DPM Mode register controls the ADC state. The idle state of the ADC does not acquire data from any input of the DPM. Normal operating mode has the ADC acquiring data in a systematic way.

TABLE 10. 0xD2 SET DPM MODE REGISTER BIT 5 DEFINED

D5	ADC STATE
0	Normal State
1	ADC in Idle State

## POST TRIGGER STATE D[4]

Data bit 4 of the Set DPM Mode register controls the post ADC state once an acquisition has been made in the trigger mode.

TABLE 11. 0xD2 SET DPM MODE REGISTER BIT 4 DEFINED

D4	ADC TRIGGER STATE
0	Idle Mode after a Trigger Measurement
1	PD Mode after Trigger Measurement

## ADC MODE TYPE D[3]

Data Bit 3 of the Set DPM Mode register controls the behavior of the ADC to either triggered or continuous. The continuous mode has the ADC continuously acquiring data in a systematic manor described by data bits [2:0] in the SET DPM MODE register. The triggered mode instructs the ADC to make an acquisition described by data bits [2:0]. The beginning of a triggered cycle starts once writing to the Set DPM Mode register commences. The trigger mode is useful for reading a single measurement per acquisition cycle.

TABLE 12. 0xD2 SET DPM MODE REGISTER BIT 3 DEFINED

D3	ADC MODE TYPE
0	Trigger
1	Continuous

## OPERATING MODE D[2:0]

The Operating Mode bits of the Set DPM Mode register control the state machine within the chip. The state machine globally controls the overall functionality of the chip. [Table 13](#) shows the various measurement states the chip can be configured to, as well as the mode bit definitions to achieve a desired measurement state. The shaded row is the default setting upon power-up.

TABLE 13. 0xD2 SET DPM MODE REGISTER BITS 2 TO 0 DEFINED

D[2:0]	MEASUREMENT INPUT
0	Primary Channel Shunt Voltage
1	Primary Channel $V_{BUS}$ Voltage
2	Primary Shunt and $V_{BUS}$ Voltages
3	Do Not Select
4	Auxiliary Channel $V_{BUS}$ Voltage
5	Do Not Select
6	Internal Temperature
7	All

## 0XD3 DPM CONVERSION STATUS (R)

The DPM conversion status register is a readable byte register that reports the status of a conversion when the DPM is programmed in the trigger mode.

TABLE 14. 0xD3 DPM CONVERSION STATUS REGISTER DEFINITION

BIT NUMBER	D[7:2]	D[1]	D[0]
Bit Name	N/A	CNVR	OVF
Default Value	0	0	0

## CNVR: CONVERSION READY D[1]

The Conversion Ready bit indicates when the ADC has finished a conversion and has transferred the reading(s) to the appropriate register(s). The CNVR is only operable when the ADC state is set to trigger. The CNVR is in a high state when the conversion is in progress. When the CNVR bit transitions from a high state to a low state and remains at a low state, is when the conversion is complete. The CNVR initializes or reinitializes when writing to the Set DPM Mode register.

## OVF: MATH OVERFLOW FLAG D[0]

The Math Overflow Flag (OVF) bit is set to indicate the current and power data being read from the DPM is overranged and meaningless.

## 0XD4 CONFIGURE I<sub>CHANNEL</sub> (R/W)

The Configure I<sub>CHANNEL</sub> register is a read/writable word register that configures the ADC measurement acquisition settings for the primary and auxiliary voltage shunt inputs.

TABLE 15. 0xD4 CONFIGURE I<sub>CHANNEL</sub> REGISTER DEFINITION

BIT NUMBER	D[15:7]	D[13:10]	D[9:7]	D[6:3]	D[2:0]
Bit Name	N/A	N/A	N/A	Prim Shunt Sample AVG	Prim Shunt Conversion Time
Default Value	00	00 00	11 1	000 0	111

## SHUNT VOLTAGE CONVERSION TIME D[2:0]

The Shunt Voltage Conversion Time bits set the acquisition speed of the ADC when measuring the primary voltage shunt channel of the DPM. The primary voltage shunt channel has independent timing control bits allowing for the primary voltage shunt channel to have a unique acquisition time with the respect to other channels within the DPM. [Table 16](#) is a list of the selectable voltage shunt ADC time settings. The shaded row indicates the default setting.

**TABLE 16. PRIMARY VSHUNT CONVERSION TIMES DEFINED**

Config_Ichannel: D[2:0]			CONVERSION TIME
0	0	0	64μs
0	0	1	128μs
0	1	0	256μs
0	1	1	512μs
1	0	X	1.024ms
1	1	X	2.048ms

**SHUNT VOLTAGE SAMPLE AVERAGE D[6:3]**

The Shunt Voltage Sample Average bits set the number of averaging samples for a unique sampling time. The DPM records all samples and outputs the average resultant to the voltage shunt register. Table 17 defines the list of selectable averages the DPM can be set to. The shaded row indicates the default setting.

**TABLE 17. PRIMARY VSHUNT NUMBER OF SAMPLES TO AVERAGE DEFINED**

AVG[3:0]				CONVERTER AVERAGES
0	0	0	0	1
0	0	0	1	2
0	0	1	0	4
0	0	1	1	8
0	1	0	0	16
0	1	0	1	32
0	1	1	0	64
0	1	1	1	128
1	0	0	0	256
1	0	0	1	512
1	0	1	0	1024
1	0	1	1	2048
1	1	X	X	4096

**0X38 IOUT CALIBRATION GAIN (R/W)**

The IOUT Calibration Gain register is a read/writable word register that is used to calculate current and power measurements for the primary channel of the DPM. When the register is programmed, the DPM calculates the current and power based on the primary channels V<sub>BUS</sub> and V<sub>SHUNT</sub> measurements. The calculation resultant is stored in the READ\_IOUT and READ\_POUT registers.

The calibration register value can be calculated as follows:

1. Calculate the full scale current range that is desired. This can be calculated using Equation 3.

$$\text{Current}_{FS} = \frac{V_{shunt_{FS}}}{R_{shunt}} \quad (\text{EQ. 3})$$

R<sub>shunt</sub> is the value of the shunt resistor. V<sub>shunt<sub>FS</sub></sub> is the full scale range of the primary channel, which equals 80mV.

2. From the current full-scale range, the current LSB can be calculated using Equation 4. Current full-scale is the outcome from Equation 3.

$$\text{Current}_{LSB} = \frac{\text{Current}_{FS}}{\text{ADC}_{res}} \quad (\text{EQ. 4})$$

ADC<sub>res</sub> is the resolution of shunt voltage reading. The output of the ADC is a signed 15 bit binary number. Therefore, the ADC<sub>res</sub> value equals 2<sup>15</sup> or 32768.

From Equation 4, the calibration resistor value can be calculated using Equation 5. The resolution of the math that is processed internally in the DPM is 2048 or 11 bits of resolution. The V<sub>SHUNT</sub> LSB is set to 2.5μV. Equation 5 yields a 15-bit binary number that can be written to the calibration register. The calibration register format is represented in Table 18.

$$\text{CalReg}_{val} = \text{integer} \left[ \frac{\text{Math}_{res} \cdot V_{shunt_{LSB}}}{(\text{Current}_{LSB} \cdot R_{shunt})} \right]$$

$$\text{CalReg}_{val} = \text{integer} \left[ \frac{0.00512}{(\text{Current}_{LSB} \cdot R_{shunt})} \right] \quad (\text{EQ. 5})$$

**TABLE 18. 0X38 IOUT\_CAL\_GAIN DEFINITION**

BIT NUMBER	D[15]	D[14:0]
Bit Name	N/A	IOUT_CAL_GAIN
Default Value	0	000 0000 0000 0000

**0XD5 CONFIGURE VCHANNEL (R/W)**

The Configure V<sub>CHANNEL</sub> register is a read/writable word register that configures the ADC measurement acquisition settings for the primary and auxiliary voltage bus inputs.

**TABLE 19. 0XD5 CONFIGURE VCHANNEL REGISTER DEFINITION**

BIT NUMBER	D[15:14]	D[13:10]	D[9:7]	D[6:3]	D[2:0]
Bit Name	N/A	AuxV Sample AVG	AuxV Conversion Time	V <sub>BUS</sub> Sample AVG	V <sub>BUS</sub> Conversion Time
Default Value	00	00 00	11 1	000 0	111

The ADC configuration of the sampling average and conversion time settings for V<sub>BUS</sub> and AuxV channels have the same setting choices as the V<sub>SHUNT</sub> primary and auxiliary channels.

## 0XD7 CONFIGURE PEAK DETECTOR (R/W)

The Configure Peak Detector register is a read/writable byte register that toggles the minimum and maximum current tracking feature. A Peak Detect Enable bit setting of 1 enables the current peak detect feature of the DPM. The feature is discussed in more detail in the [“0xD8 Read Peak Min I<sub>OUT</sub> \(R\)”](#) section.

TABLE 20. 0xD7 CONFIGURE PEAK DETECTOR REGISTER DEFINITION

BIT NUMBER	D[7:1]	D[0]
Bit Name	N/A	Peak Detect En
Default Value	0000 000	0

## Measurement Registers

### 0XD6 READ V<sub>SHUNT</sub> OUT (R)

The Read V<sub>SHUNT</sub> Out register is a readable word register that stores the signed measured digital value of the primary V<sub>SHUNT</sub> input of the DPM. Using [Equation 2](#) to calculate the integer value of the register, [Equation 6](#) calculates the floating point measured value for the primary V<sub>SHUNT</sub> channel.

$$V_{SHUNT} = \text{Register}_{\text{value}} \cdot V_{SHUNT(\text{LSB})} \quad (\text{EQ. 6})$$

V<sub>SHUNT(LSB)</sub> is the numerical weight of each level for the V<sub>SHUNT</sub> channel, which equals 2.5μV.

### 0X8B READ V<sub>OUT</sub> (R)

The Read V<sub>OUT</sub> register is a readable word register that stores the unsigned measured digital value of the primary V<sub>BUS</sub> input of the DPM. Using [Equation 1](#) to calculate the integer value of the register, [Equation 7](#) calculates the floating point measured value for the primary V<sub>BUS</sub> channel.

$$V_{BUS} = \text{Register}_{\text{value}} \cdot V_{BUS(\text{LSB})} \quad (\text{EQ. 7})$$

V<sub>BUS(LSB)</sub> is the numerical weight of each level for the V<sub>BUS</sub> channel. The V<sub>BUS(LSB)</sub> equals 1mV for the 60V version of the DPM and 250μV for the 12V version of the DPM.

### 0X8C READ I<sub>OUT</sub> (R)

The Read I<sub>OUT</sub> register is a readable word register that stores the signed measured digital value of the current passing through the primary channel's shunt. The register uses the measured value from V<sub>SHUNT</sub> and the I<sub>OUT\_CAL\_GAIN</sub> register. [Equation 8](#) yields the current for the primary channel.

$$\text{Current} = \text{Register}_{\text{value}} \cdot \text{Current}_{\text{LSB}} \quad (\text{EQ. 8})$$

The Register<sub>value</sub> is calculated using [Equation 2](#). The Current<sub>LSB</sub> is calculated using [Equation 4](#).

### 0XD8 READ PEAK MIN I<sub>OUT</sub> (R)

### 0XD9 READ PEAK MAX I<sub>OUT</sub> (R)

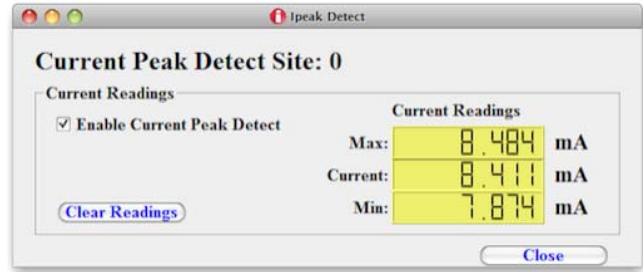

FIGURE 66. THE ISL28025 TRACKS MINIMUM AND MAXIMUM AVERAGE CURRENT READINGS

The Read Peak Min/Max I<sub>OUT</sub> registers are readable word registers that store the minimum and maximum current value of an averaging cycle for the current passing through the primary shunt.

The min/max current tracking is enabled by setting the Peak Detect Enable bit in the CONFIG\_PEAK\_DET (0xD7) register. The current peak detect feature only works for the current register.

At the conclusion of each primary channel current, the DPM will record and store the minimum and maximum values of the current measured. The feature operates for both the trigger and continuous modes. Disabling the Peak Detector Enable bit will turn off the feature as well as clear the Read Peak Min/Max I<sub>OUT</sub> registers.

### 0X96 READ P<sub>OUT</sub> (R)

The Read P<sub>OUT</sub> register is a signed readable word register that reports the digital value of the power from the primary channel. The register uses the values from READ\_I<sub>OUT</sub> and READ\_V<sub>SHUNT\_OUT</sub> registers to calculate the power.

The units for the power register are in watts. The power can be calculated using [Equation 9](#).

$$\text{Power} = \text{Register}_{\text{value}} \cdot \text{Power}_{\text{LSB}} \cdot 40000 \quad (\text{EQ. 9})$$

The Register<sub>value</sub> is calculated using [Equation 2 on page 24](#). The Power<sub>LSB</sub> can be calculated from [Equation 10](#).

$$\text{Power}_{\text{LSB}} = \text{Current}_{\text{LSB}} \cdot V_{\text{BUS}(\text{LSB})} \quad (\text{EQ. 10})$$

The V<sub>BUS(LSB)</sub> equals 1mV for the 60V version of the DPM and 250μV for the 12V version of the DPM. The Current<sub>LSB</sub> is the value yielded from [Equation 4](#).

### 0XE1 READ V<sub>OUT</sub> AUX (R)

The Read V<sub>out</sub> Aux register is a readable word register that stores the unsigned measured digital value of the auxiliary V<sub>BUS</sub> input of the DPM. Using [Equation 1 on page 24](#) to calculate the integer value of the register, [Equation 11](#) calculates the floating point measured value for the auxiliary V<sub>BUS</sub> channel.

$$V_{BUS} = \text{Register}_{\text{value}} \cdot V_{\text{BUS}(\text{LSB})} \quad (\text{EQ. 11})$$

V<sub>BUS(LSB)</sub> is the numerical weight of each level for the auxiliary V<sub>BUS</sub> channel. The auxiliary V<sub>BUS(LSB)</sub> equals 100μV. The voltage range for the auxiliary V<sub>BUS</sub> is 0 to VCC.

## 0X8D READ TEMPERATURE (R)

The read temperature register is a readable word register that reports out the internal temperature of the chip. The register is a 16-bit signed register. Bit 15 of the register is the signed bit. The register value can be calculated using [Equation 12](#).

$$\text{Register Value} = \left[ \sum_{n=0}^{14} \left( \text{Bit\_Val}_n \cdot 2^n \right) \right] - \left( \text{Bit\_Val}_{15} \cdot 2^{15} \right) \quad (\text{EQ. 12})$$

n is the bit position within the register value. Bit\_Val is the value of the bit either 1 or 0. The register value multiplied by 0.016 yields the internal temperature reading in Centigrade (°C).

## Threshold Detectors

The DPM has three integrated comparators that allow for real time fault detection of overvoltage, undervoltage for the primary V<sub>BUS</sub> input and an overcurrent detection for the primary V<sub>SHUNT</sub> input. An over-temperature detection is available by multiplexing the input to the overvoltage comparator.

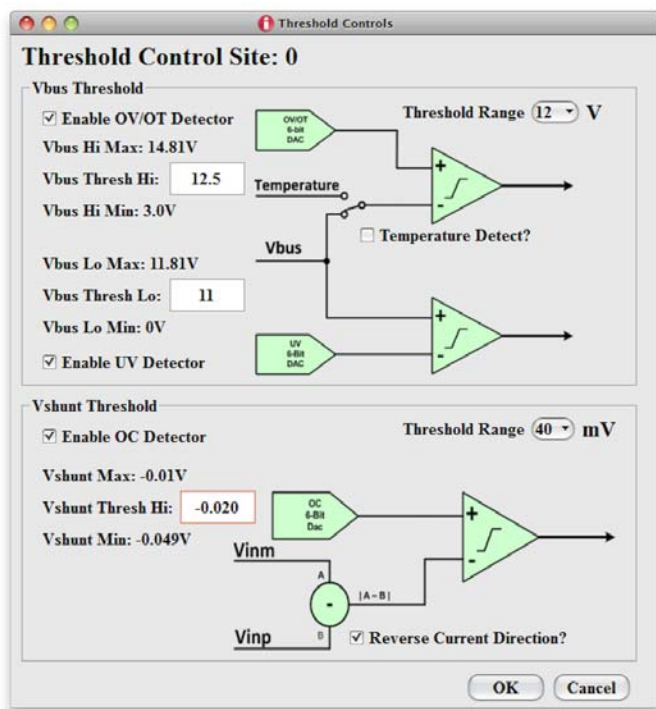

FIGURE 67. SIMPLIFIED BLOCK DIAGRAM OF THE THRESHOLD FUNCTIONS WITHIN THE DPM

## 0XDA VOUT OV THRESHOLD SET (R/W)

The VOUT OV Threshold Set register is a read/writable word register that controls the threshold voltage level to the overvoltage comparator. The description of the functionality within this register is found in [Table 21](#).

The compared reference voltage level to the OV comparator is generated from a 6-bit DAC. The 6-bit DAC has 4 or 6 voltage ranges to improve detection voltage resolution for a specific voltage range

TABLE 21. 0xDA VOUT OV THRESHOLD SET REGISTER DEFINITION

BIT NUMBER	D[15:10]	D[9]	D[8:6]	D[5:0]
Bit Name	N/A	OV_OT_SEL	Vbus_Thres_Rng	Vbus_OV_OT_Set
Default Value	0000 00	0	0 00	11 1111

### OV\_OT\_SEL D[9]

The OV\_OT\_SEL bit configures the multiplexer to the input of the OV comparator to either compare for over-temperature or overvoltage. Setting the OV\_OT\_SEL to a 1 configures the OV comparator to detect for an over-temperature condition.

### VBUS\_THRES\_RNG D[8:6]

The Vbus\_Thres\_Rng bits sets the threshold voltage range for the overvoltage and undervoltage DACs. There are 6 selectable ranges for the 60V version of the DPM. Only 4 selectable ranges for the 12V version of the DPM. [Table 22](#) defines the range settings for the V<sub>BUS</sub> threshold detector. The yellow shaded row denotes the default setting.

The temperature threshold reference level has one range setting which equals +125°C at full scale.

TABLE 22. Vbus\_Thres\_Rng BITS DEFINED

Vbus_Thres_Rng: D[8:6]			Vbus_12V (RANGE)	Vbus_60V (RANGE)
0	0	0	12	48
0	0	1	6	24
0	1	0	3	12
0	1	1	1.25	5
1	0	0	X	3.3
1	0	1	X	2.5

### VBUS\_OV\_OT\_SET D[5:0]

The Vbus\_OV\_OT\_Set bits controls the voltage/temperature level to the input of the OV comparator. The LSB of the DAC is 1.56% of the full scale range chosen using the Vbus\_Thres\_Rng bits. For the temperature feature, the LSB for the temperature level is 5.71°C. The mathematical range is -144°C to +221.4°C.

The overvoltage range starts at 25% of the full scale range chosen using the Vbus\_Thres\_Rng bits and ends at 125% of the chosen full scale range. The same range applies to the temperature measurements.



**TABLE 23. Vbus\_OV\_OT\_Set BITS DEFINED**

Vbus_OV_OT_Set: D[5:0]	OV THRESHOLD VALUE	OT THRESHOLD VALUE
00 0000	25% of FS	-144
00 0001	(25 + 1.56)% of FS	-138.3
00 0010	(25 + 3.12)% of FS	-132.6
.....	.....	.....
11 1101	(125 to 4.68)% of FS	210
11 1110	(125 to 3.12)% of FS	215.7
11 1111	(125 to 1.56)% of FS	221.4

Table 23 defines an abbreviated breakdown to set the OV/OT comparator level. The shaded row is the default condition.

### OXDB VOUT UV THRESHOLD SET (R/W)

The V<sub>OUT</sub> UV Threshold Set register is a read/writable byte register that controls the threshold voltage level to the undervoltage comparator. The description of the functionality within this register is found in Table 24.

The compared reference voltage level to the UV comparator is generated from a 6-bit DAC. The 6-bit DAC has 4 to 6 voltage ranges that are determined by the Vbus\_Thres\_Rng bits in the Vout OV Threshold Set register.

**TABLE 24. OXDB VOUT UV THRESHOLD SET REGISTER DEFINITION**

BIT NUMBER	D[7:6]	D[5:0]
Bit Name	N/A	Vbus_UV_Set
Default Value	00	00 0000

### VBUS\_UV\_SET D[4:0]

The Vbus\_UV\_Set bits control the undervoltage level to the input of the UV comparator. The LSB of the DAC is 1.56% of the full scale range chosen using the Vbus\_Thres\_Rng bits.

The undervoltage ranges from 0% to 100% of the full scale range set by the Vbus\_Thres\_Rng bits.

**TABLE 25. Vbus\_UV\_Set BITS DEFINED**

Vbus_UV_Set: D[5:0]	UV THRESHOLD VALUE
00 0000	0%
00 0001	1.56% of FS
00 0010	3.12% of FS
.....	.....
11 1101	(100 to 4.68)% of FS
11 1110	(100 to 3.12)% of FS
11 1111	(100 to 1.56)% of FS

Table 25 defines an abbreviated breakdown to set the undervoltage comparator levels. The shaded row is the default condition.

### OXDC I<sub>OUT</sub> OC THRESHOLD SET (R/W)

The I<sub>OUT</sub> OC Threshold Set register is a read/writable word register that controls the threshold current level to the overcurrent comparator. The description of the functionality within this register is found in Table 26.

**TABLE 26. OXDC I<sub>OUT</sub> OC THRESHOLD SET REGISTER DEFINITION**

BIT NUMBER	D[15:10]	D[9]	D[8:7]	D[6]	D[5:0]
Bit Name	N/A	Iout_Dir	N/A	Vshunt Thres Rng	Vshunt_OC_Set
Default Value	0000 00	0	0 0	0	11 1111

The overcurrent threshold is defined through the V<sub>SHUNT</sub> reading. The product of the current through the shunt resistor defines the V<sub>SHUNT</sub> voltage to the DPM. The current through the shunt resistor is directly proportional the V<sub>SHUNT</sub> voltage measured by the DPM. An overvoltage threshold for V<sub>SHUNT</sub> is the same as an overcurrent threshold.

### I<sub>OUT</sub>\_DIR D[9]

The Iout\_Dir bit controls the polarity of the V<sub>SHUNT</sub> voltage threshold. The bit functionality allows an overcurrent threshold to be set for currents flowing from VINP to VINM and the reverse direction. Table 27 defines the range settings for the V<sub>BUS</sub> threshold detector. The yellow shaded row denotes the default setting.

**TABLE 27. Vbus\_Thres\_Rng BITS DEFINED**

Iout_Dir: D[9]	CURRENT DIRECTION
0	VINP to VINM
1	VINM to VINP

### VSHUNT\_THRES\_RNG D[6]

The Vshunt\_Thres\_Rng bit sets the overvoltage threshold range for the overcurrent DAC. The selectable V<sub>SHUNT</sub> range improves the overvoltage threshold resolution for lower full scale current applications. Table 28 defines the range settings for the V<sub>BUS</sub> threshold detector. The yellow shaded row denotes the default setting.

**TABLE 28. Vshunt\_Thres\_Rng BIT DEFINED**

Vshunt_Thres_Rng: D[6]	VSHUNT (RANGE)
0	80mV
1	40mV

## VSHUNT\_OC\_SET D[5:0]

The Vshunt\_OC\_Set bits controls the  $V_{SHUNT}$  voltage level to the input of the OC comparator. The LSB of the DAC is 1.56% of the full scale range chosen using the Vshunt\_Thres\_Rng bits.

The overvoltage range starts at 25% of the full scale range chosen using Vbus\_Thres\_Rng bits and ends at 125% of the chosen full scale range.

TABLE 29. Vshunt\_OC\_Set BITS DEFINED

Vshunt_OC_Set: D[5:0]	OC THRESHOLD VALUE
00 0000	25% of FS
00 0001	(25 + 1.56)% of FS
00 0010	(25 + 3.12)% of FS
.....	.....
11 1101	(125 to 4.68)% of FS
11 1110	(125 to 3.12)% of FS
11 1111	(125 to 1.56)% of FS

## SMB Alert

The DPM has two alert pins (SMBALERT1, SMBALERT2) to alert the peripheral circuitry that a failed event has occurred. SMBALERT1 output is an open drain allowing the user the flexibility to connect the alert pin to other components requiring different logic voltage levels than the DPM. The SMBALERT2 has a push/pull output stage for driving pins with logic voltage levels equal to the voltage applied to I2CVCC pin. The push/pull output is useful for driving peripheral components that require the DPM to source and sink a current. The alert pins are commonly connected to an interrupt pin of a microcontroller or an enable pin of a device.

The SMBALERT registers control the functionality of the SMBALERT pins. The threshold comparators are the inputs to the SMBALERT registers. The output are the SMBALERT pins. [Figure 68](#) is a simple functional block diagram of the SMB Alert features.

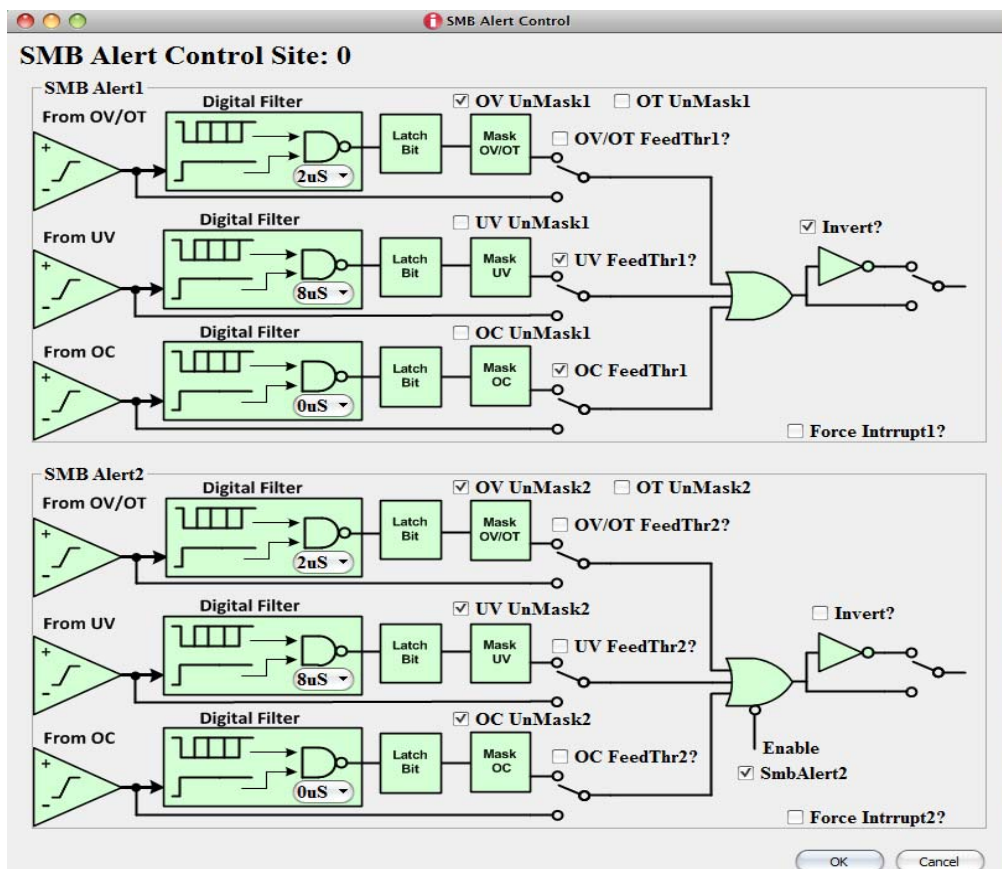

FIGURE 68. SIMPLIFIED BLOCK DIAGRAM OF THE SMBALERT FUNCTIONS WITHIN THE DPM

## OXDD CONFIGURE INTERRUPTS (R/W)

The Configure Interrupt register is a read/writable word register that controls the behavior of the two SMBALERT pins. The definition of the control bits within the Configure Interrupt register is defined in [Table 30](#).

**TABLE 30. 0xDD CONFIGURE INTERRUPT REGISTER DEFINITION**

BIT NUMBER	D [15]	D [14:12]	D [11:9]	D [8:7]	D [6:5]	D [4:3]	D [2]	D [1]	D [0]
Bit Name	N/A	ALERT2 FeedTh	ALERT1 FeedTh	OC FIL	OV FIL	UV FIL	OC EN	OV EN	UV EN
Default Value	0	000	000	0 0	00	0 0	0	0	0

### ALERT2\_FEEDTHR D[14:12]

The Alert2\_FeedThr bits determine whether the bit from each alert comparator is digitally conditioned or not. The alert comparators, digital filters and latching bits are the same for both SMBALERT channels. [Table 31](#) defines the functionality of the Alert2\_FeedThr bits.

**TABLE 31. Alert2\_FeedThr BITS DEFINED**

Alert2_FeedThr Bits D[14:12]	BIT VALUE	FUNCTIONALITY
D[14]	0	OV/OT Digitally Conditioned
	1	OV/OT Pass Through
D[13]	0	UV Digitally Conditioned
	1	UV Pass Through
D[13]	0	OC Digitally Conditioned
	1	OC Pass Through

### ALERT1\_FEEDTHR D[11:9]

The Alert1\_FeedThr bits determine whether the bit from each alert comparator is digitally conditioned or not. The alert comparators, digital filters and latching bits are the same for both SMB alert channels. [Table 32](#) defines the functionality of the Alert1\_FeedThr bits.

**TABLE 32. Alert1\_FeedThr BITS DEFINED**

Alert1_FeedThr Bits D[11:9]	BIT VALUE	FUNCTIONALITY
D[11]	0	OV/OT Digitally Conditioned
	1	OV/OT Pass Through
D[10]	0	UV Digitally Conditioned
	1	UV Pass Through
D[9]	0	OC Digitally Conditioned
	1	OC Pass Through

### OC\_FIL D[8:7]

The OC\_FIL bits control the digital filter for the overcurrent circuitry. The digital filter will prevent short duration events from passing to the output pins. The filter is useful in preventing high frequency power glitches from triggering a shutdown event. The filter time delay ranges from 0 $\mu$ s to 8 $\mu$ s. An 8 $\mu$ s filter setting requires an error event to be at least 8 $\mu$ s in duration before passing the result to the SMBALERT pins. There is one OC digital filter for both SMBALERT pins. Configuring OC\_FIL bits will change the OC digital filter setting for both SMBALERT pins. See [Table 33](#) for the filter selections.

### UV\_FIL D[6:5]

The UV\_FIL bits control the digital filter for the undervoltage circuitry. The digital filter will prevent short duration events from passing to the output pins. The filter is useful in preventing high frequency power glitches from triggering a shutdown event. The filter time delay ranges from 0 $\mu$ s to 8 $\mu$ s. An 8 $\mu$ s filter setting requires an error event to be at least 8 $\mu$ s in duration before passing the result to the SMBALERT pins. There is one UV digital filter for both SMBALERT pins. Configuring UV\_FIL bits will change the UV digital filter setting for both SMBALERT pins. See [Table 33](#) for the filter selections.

### OV\_FIL D[4:3]

The OV\_FIL bits control the digital filter for the overvoltage circuitry. The digital filter will prevent short duration events from passing to the output pins. The filter is useful in preventing high frequency power glitches from triggering a shutdown event. The filter time delay ranges from 0 $\mu$ s to 8 $\mu$ s. An 8 $\mu$ s filter setting requires an error event to be at least 8 $\mu$ s in duration before passing the result to the SMBAlert pins. There is one OV digital filter for both SMB alert pins. Configuring OV\_FIL bits will change the OV digital filter setting for both SMB alert pins. See [Table 33](#) for the filter selections.

**TABLE 33. DIGITAL GLITCH FILTER SETTINGS DEFINED**

OC_FIL D[8:7]	UV_FIL D[6:5]	OV_FIL D[4:3]	FILTER TIME ( $\mu$ s)
0	0	0	0
0	1	0	2
1	0	0	4
1	1	0	8

### OC\_EN D[2]

The OC\_EN enable bit controls the power to the overcurrent DAC and comparator. Setting the bit to 1 enables the overcurrent circuitry.

### OV\_EN D[1]

The OV\_EN enable bit controls the power to the overvoltage DAC and comparator. Setting the bit to 1 enables the overvoltage circuitry.



## UV\_EN D[0]

The UV\_EN enable bit controls the power to the undervoltage DAC and comparator. Setting the bit to 1 enables the undervoltage circuitry.

## 0XDE FORCE FEED-THROUGH ALERT REGISTER (R/W)

The Force Feed-through Alert Register is a read/writable byte register that controls the polarity of the interrupt. The definition of the control bits within the Force Feed-through Alert register is defined in [Table 34](#).

**TABLE 34. 0xDE FORCE FEED-THROUGH ALERT REGISTER DEFINITION**

BIT NUMBER	D[7:4]	D[3]	D[2]	D[1]	D[0]
Bit Name	N/A	A2POL	A1POL	FORCE A2	FORCE A1
Default Value	0000	0	0	0	0

## A2POL D[3], A1POL D[2]

The AxPOL bits control the polarity of an interrupt. A2POL bit defines the SMBALERT2 pin active interrupt state. A1POL bit defines the SMBALERT1 pin active interrupt state. [Table 35](#) defines the functionality of the bit.

**TABLE 35. AxPOL BIT DEFINED**

A2POL D[3], A1POL D[2]	INTERRUPT ACTIVE STATE
0	low
1	high

## FORCEA2 D[1], FORCEA1 D[0]

The FORCEAx bits allow the user to force an interrupt by setting the bit. FORCEA2 bit controls the SMBALERT2 pin state. FORCEA1 bit controls the SMBALERT1 pin state. [Table 36](#) defines the functionality of the bit.

**TABLE 36. FORCEAx BIT DEFINED**

FORCEA2 D[1], FORCEA1 D[0]	INTERRUPT STATUS
0	Normal
1	Interrupt Forced

## 0X03 CLEAR FAULTS (S)

The Clear Faults register is a send byte command that clears all faults pertaining to the status registers. Upon execution of the command, the status registers returns to the default state defined in [Table 2 on page 22](#).

## 0X7A STATUS V<sub>OUT</sub> (R/W)

The Status V<sub>OUT</sub> register is a read/writable byte register that reports over and undervoltage warnings for the V<sub>BUS</sub> input.

**TABLE 37. 0x7A STATUS V<sub>OUT</sub> REGISTER DEFINITION**

BIT NUMBER	D[7]	D[6]	D[5]	D[4:0]
Bit Name	N/A	V <sub>OUT</sub> OV Warning	V <sub>OUT</sub> UV Warning	N/A
Default Value	0	0	0	0 0000

## V<sub>OUT</sub> OV WARNING D[6]

The V<sub>OUT</sub> OV Warning bit is set to 1 when an overvoltage fault occurs on the V<sub>BUS</sub> input. The V<sub>BUS</sub> overvoltage threshold is set from the V<sub>OUT</sub> OV Threshold Set register. In the event of a V<sub>BUS</sub> overvoltage condition, the V<sub>OUT</sub> OV Warning is latched to 1. Writing a 1 to the V<sub>OUT</sub> OV Warning bit will clear the warning resulting in a bit value equal to 0.

## V<sub>OUT</sub> UV WARNING D[5]

The V<sub>OUT</sub> UV Warning bit is set to 1 when an undervoltage fault occurs on the V<sub>BUS</sub> input. The V<sub>BUS</sub> undervoltage threshold is set from the V<sub>OUT</sub> UV Threshold Set register. In the event of a V<sub>BUS</sub> undervoltage condition, the V<sub>OUT</sub> UV Warning is latched to 1. Writing a 1 to the V<sub>OUT</sub> UV Warning bit will clear the warning resulting in a bit value equal to 0.

## 0X7B STATUS I<sub>OUT</sub> (R/W)

The Status I<sub>OUT</sub> register is a read/writable byte register that reports an overcurrent warning for the V<sub>SHUNT</sub> input.

**TABLE 38. 0x7B STATUS I<sub>OUT</sub> REGISTER DEFINITION**

BIT NUMBER	D[7]	D[6]	D[5]	D[4:0]
Bit Name	N/A	N/A	I <sub>OUT</sub> OC Warning	N/A
Default Value	0	0	0	0 0000

## I<sub>OUT</sub> OC WARNING D[5]

The I<sub>OUT</sub> OC Warning bit is set to 1 when an overcurrent fault occurs on the V<sub>SHUNT</sub> input. The V<sub>SHUNT</sub> overcurrent threshold is set from the I<sub>OUT</sub> OC Threshold Set register. In the event of a V<sub>SHUNT</sub> overcurrent condition, the I<sub>OUT</sub> OC Warning is latched to 1. Writing a 1 to the I<sub>OUT</sub> OC Warning bit will clear the warning resulting in a bit value equal to 0.

## 0X7D STATUS TEMPERATURE (R/W)

The Status Temperature register is a read/writable byte register that reports an over-temperature warning initiated from the internal temperature sensor.

**TABLE 39. 0x7D STATUS TEMPERATURE REGISTER DEFINITION**

BIT NUMBER	D[7]	D[6]	D[5]	D[4:0]
Bit Name	N/A	OT Warning	N/A	N/A
Default Value	0	0	0	0 0000

## OT WARNING D[6]

The OT Warning bit is set to 1 when an over-temperature fault occurs from the internal temperature sensor. The over-temperature threshold is set from the  $V_{OUT}$  OV Threshold Set register. In the event of an over-temperature condition, the OT Warning bit is latched to 1. Writing a 1 to the OT Warning bit will clear the warning resulting in a bit value equal to 0.

## 0X7E STATUS CML (R/W)

The Status CML register is a read/writable byte register that reports warnings and errors associated with communications, logic and memory.

TABLE 40. 0x7E STATUS CML REGISTER DEFINITION

BIT NUMBER	D[7]	D[6]	D[5]	D[4:2]	D[1]	D[0]
Bit Name	USCMD	USDATA	PECERR	N/A	COMERR	N/A
Default Value	0	0	0	0 00	0	0

### USCMD D[7]

The USCMD bit is set to 1 when an unsupported command is received from the I<sup>2</sup>C master. Reading from an undefined register is an example of an action that would set the USCMD bit. The USCMD bit is a latched bit. Writing a 1 to the USCMD bit clears the warning resulting in a bit value equal to 0.

### USDATA D[6]

The USDATA bit is set to 1 when an unsupported data is received from the I<sup>2</sup>C master. Writing a word to a byte register is an example of an action that would set the USDATA bit. The USDATA bit is a latched bit. Writing a 1 to the USDATA bit clears the warning resulting in a bit value equal to 0.

### PECERR D[5]

The PECERR bit is set to 1 when a Packet Error Check (PEC) event has occurred. Writing the wrong PEC to the DPM is an example of an action that would set the PECERR bit. The PECERR bit is a latched bit. Writing a 1 to the PECERR bit clears the warning resulting in a bit value equal to 0.

### COMERR D[1]

The COMERR bit is set to 1 for communication errors that are not handled by the USCMD, USDATA and PECERR errors. Reading from a write only register is an example of an action that would set the COMERR bit. The COMERR bit is a latched bit. Writing a 1 to the COMERR bit clears the warning resulting in a bit value equal to 0.

## 0X78 STATUS BYTE (R/W)

The Status Byte register is a read/writable byte register that is a hierarchal register to the Status Temperature and Status CML registers. The Status Byte registers bits are set if an over-temperature or a CML error has occurred.

TABLE 41. 0x78 STATUS BYTE REGISTER DEFINITION

BIT NUMBER	D[7]	D[6:3]	D[2]	D[1]	D[0]
Bit Name	BUSY	N/A	Temperature	CML	N/A
Default Value	0	000 0	0	0	0

### BUSY D[7]

The BUSY bit is set to 1 when the DPM is busy and unable to respond. The BUSY bit is a latched bit. Writing a 1 to the BUSY bit clears the warning resulting in a bit value equal to 0.

### TEMPERATURE D[2]

The Temperature bit is set to 1 when an over-temperature fault occurs from the internal temperature sensor. This bit is the same action bit as the OT Warning bit in the Status Temperature register. The over-temperature threshold is set from the  $V_{OUT}$  OV Threshold Set register. In the event of an over-temperature condition, the Temperature bit is latched to 1. Writing a 1 to the Temperature bit will clear the warning resulting in a bit value equal to 0.

### CML D[1]

The CML bit is set to 1 when any errors occur within the Status CML register. There are four Status CML error bits that can set the CML bit. The CML bit is a latched bit. Writing a 1 to the CML bit clears the warning resulting in a bit value equal to 0.

## 0X79 STATUS WORD (R/W)

The Status Word register is a read/writable word register that is a hierarchal register to the Status  $V_{OUT}$ , Status  $I_{OUT}$  and Status Byte registers. The Status Word registers bits are set when any errors previously described occur. The register generically reports all errors.

TABLE 42. 0x79 STATUS WORD REGISTER DEFINITION

BIT NUMBER	D[15]	D[14]	D[13:8]	D[7:0]
Bit Name	$V_{OUT}$	$I_{OUT}$	N/A	See Status Byte
Default Value	0	0	00 0000	0000 0000

### $V_{OUT}$ D[15]

The  $V_{OUT}$  bit is set to 1 when any errors occur within the Status  $V_{OUT}$  register. Whether either or both an undervoltage or overvoltage fault occurs, the  $V_{OUT}$  bit will be set. The  $V_{OUT}$  bit is a latched bit. Writing a 1 to the  $V_{OUT}$  bit clears the warning resulting in a bit value equal to 0.

### $I_{OUT}$ D[14]:

The  $I_{OUT}$  bit is set to 1 when an overcurrent fault occurs. This bit is the same action bit as the  $I_{OUT}$  OC Warning bit in the Status  $I_{OUT}$  register. In the event of an overcurrent condition, the  $I_{OUT}$  bit is latched to 1. Writing a 1 to the  $I_{OUT}$  bit will clear the warning resulting in a bit value equal to 0.

## 0X1B SMBALERT MASK (BR/BW)

## 0XDF SMBALERT2 MASK (BR/BW)

The SMBALERT registers are block read/writable registers that mask error conditions from electrically triggering the respective SMBALERT pin.

The SMBALERT can mask bits of any of the status registers. Masking lower level bits prevents the hierarchal bit from being set. For example, a COMERR bit being masked will not set the CML bit of the Status Byte register.

To mask a bit, the first data byte is the register address of the bit(s) to be masked. The second and third data bytes are the masking bits of the register. A masking bit of 1 prevents the signal from triggering an interrupt.

All alert bits are masked as the default state for both the SMB alert pins. The master needs to send instructions to unmask the alert bits.

As an example, a user would like to allow the COMERR bit to trigger a SMBALERT2 interrupt while masking the rest of the alerts within the Status CML register. The command that is sent from the master to the DPM is the slave address, SMBALERT2 register address, Status CML register address and the mask bit value. In a hexadecimal format, the data sent to the DPM is as follows; 0x80 DF 7E FD.

To read the mask status of any alert register, a four byte write command, without PEC, consisting of the slave address of the device, the SMB mask register address, the number of bytes to be read back and the register address of the mask to be read. Once the write command has commenced, a read command consisting of the device slave address and the register address of the SMB mask will return the mask of the desired alert register.

As an example, a user would like to read the status of the Status Byte register. The first command sent to the DPM is in hexadecimal bytes is 0x82 1B 01 78. The second command is a standard read. The slave address is 0x83 (0x82 + read bit set) and the register address is 0x1B.

## SMBALERT1 RESPONSE ADDRESS

It is common that the SMBALERT1 pin of each ISL28025 device is shared to a single GPIO pin of the microcontroller. The SMBALERT1 pin is an open drain allowing for multiple devices to be OR'ed to a single GPIO pin.

The SMBALERT1 Response Address command reports the slave address of the device that has triggered alert. The SMB Respond Address command is shown in [Figure 69](#).

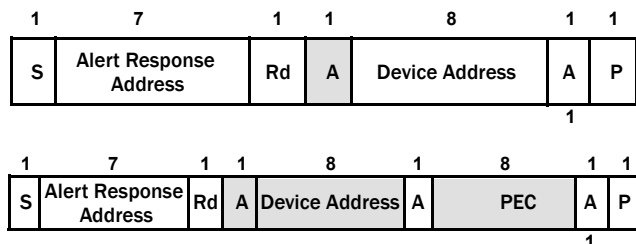

FIGURE 69. THE COMMAND STRUCTURE OF THE SMBALERT RESPONSE ADDRESS

The alert response address is 0x18. In the event of multiple alerts pulling down the GPIO line, the alert respond command will return the lowest slave address that is connected to the I<sup>2</sup>C bus. Upon clearing the lowest slave address alert, the alert command will return the lowest slave address of the remaining alerts that are activated.

The alert response is operable when the interrupt active state is forced low by the device at the SMBALERT1 pin. Changing SMBALERT1 interrupt polarity or forcing an interrupt will enable the alert response. By design the open drain of the SMBALERT1 pin allows for ANDing of the interrupt via a pull-up resistor. The alert response command is valid for only the SMBALERT1 pin. The alert response command will return a 0x19 when there are no errors detected.

## External Clock Control

The DPM has an external clock feature that allows the chip to be synchronized to an external clock. The feature is useful in limiting the number of clocks running asynchronously within a system.

## 0XE5 CONFIGURE EXTERNAL CLOCK (R/W)

The Configure External Clock register is a read/writable byte register that controls the functionality of the external clock feature.

TABLE 43. 0XE5 CONFIGURE EXTERNAL CLOCK REGISTER DEFINITION

BIT NUMBER	D[7]	D[6]	D[5:4]	D[3:0]
Bit Name	ExtCLK_EN	SMBALERT2OEN	N/A	EXTCLKDIV
Default Value	0	0	00	0000

## EXTCLK\_EN D[7]

The ExtClk\_En bit enables the external clock feature. The ExtClk\_En default bit setting is 0 or disabled. A bit setting of 1 disables the internal oscillator of the DPM and connects circuitry such that the system clock is routed from the external clock pin.

## SMBALERT2\_OEN D[6]

The SMBALERT2\_OEN bit within the Configure External Clock register either enables or disables the buffer that drives the SMBALERT2 pin.

TABLE 44. SMBALERT2\_OEN BIT DEFINED

SMBALERT_OEN	SMBALERT2 STATUS
0	Disabled
1	Enabled

## EXTCLKDIV D[3:0]

The EXTCLKDIV bits control an internal clock divider that is useful for fast system clocks. The internal clock frequency from pin to chip is represented in [Equation 13](#).

$$f_{\text{req internal}} = \frac{f_{\text{EXTCLK}}}{(\text{ClkDiv} \cdot 8) + 8} \quad (\text{EQ. 13})$$

$f_{\text{EXTCLK}}$  is the frequency of the signal driven to the External Clock pin. ClkDiv is the decimal value of the clock divide bits.

## Serial Interface

The ISL28025 supports a bidirectional bus oriented protocol. The protocol defines any device that sends data onto the bus as a transmitter and the receiving device as the receiver. The device controlling the transfer is the master and the device being controlled is the slave. The master always initiates data transfers and provides the clock for both transmit and receive operations. Therefore, the ISL28025 operates as a slave device in all applications.

The ISL28025 uses two bytes data transfer, all reads and writes are required to use two data bytes. All communication over the I<sup>2</sup>C interface is conducted by sending the MSByte of each byte of data first, followed by the LSByte.

## Protocol Conventions

For normal operation, data states on the SDA line can change only during SCL LOW periods. SDA state changes during SCL HIGH are reserved for indicating START and STOP conditions (see [Figure 70](#)). On power-up, the SDA pin is in the input mode.

All I<sup>2</sup>C interface operations must begin with a START condition, which is a HIGH-to-LOW transition of SDA while SCL is HIGH. The device continuously monitors the SDA and SCL lines for the START condition and does not respond to any command until this condition is met (see [Figure 70](#)). A START condition is ignored during the power-up sequence.

All I<sup>2</sup>C interface operations must be terminated by a STOP condition, which is a LOW-to-HIGH transition of SDA while SCL is HIGH (see [Figure 70](#)). A STOP condition at the end of a read operation or at the end of a write operation places the device in its standby mode.

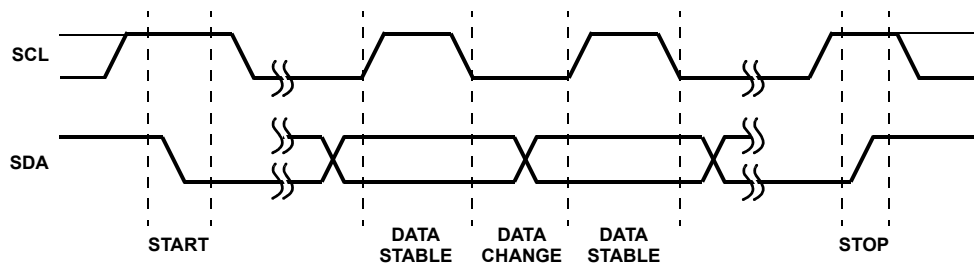

FIGURE 70. VALID DATA CHANGES, START AND STOP CONDITIONS

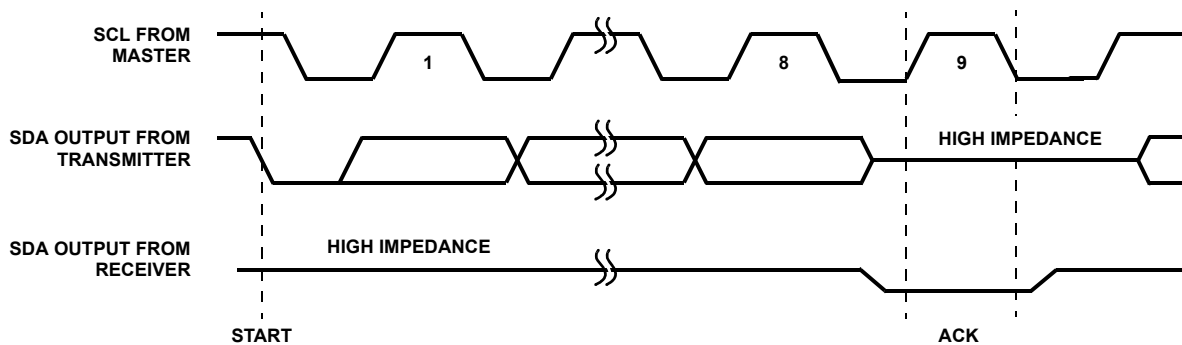

FIGURE 71. ACKNOWLEDGE RESPONSE FROM RECEIVER

## SMBus, PMBus Support

The ISL28025 supports SMBus and PMBus protocol, which is a subset of the global I<sup>2</sup>C protocol. SMBCLK and SMBDAT have the same pin functionality as the SCL and SDA pins, respectively. The SMBus operates at 100kHz. The PMBus protocol standardizes the functionality of each register by address.

## Device Addressing

Following a start condition, the master must output a slave address byte. The 7 MSBs are the device identifiers. The A0, A1 and A2 pins control the bus address (these bits are shown in [Table 45](#)). There are 55 possible combinations depending on the A0, A1 and A2 connections.

TABLE 45. I<sup>2</sup>C SLAVE ADDRESSES

A2	A1	A0	SLAVE ADDRESS
GND	GND	GND	1000 000
GND	GND	I2CVCC	1000 001
GND	GND	SDA	1000 010
GND	GND	SCL	1000 011
GND	I2CVCC	GND	1000 100
GND	I2CVCC	I2CVCC	1000 101
GND	I2CVCC	SDA	1000 110
GND	I2CVCC	SCL	1000 111
GND	SDA	GND	1001 000
GND	SDA	I2CVCC	1001 001
GND	SDA	SDA	1001 010
GND	SDA	SCL	1001 011
GND	SCL	GND	1001 100
GND	SCL	I2CVCC	1001 101
GND	SCL	SDA	1001 110
GND	SCL	SCL	1001 111
I2CVCC	GND	GND	1010 000
.....	.....	.....	.....
I2CVCC	SCL	SCL	1011 111
SDA	GND	GND	1100 000
SDA	GND	VCC	Do Not Use. Reserved
.....	.....	.....	.....
SDA	SCL	SCL	1101 111
SCL	GND	GND	1110 000
.....	.....	.....	.....
SCL	SDA	X	Do Not Use. Reserved
SCL	SCL	X	Do Not Use. Reserved

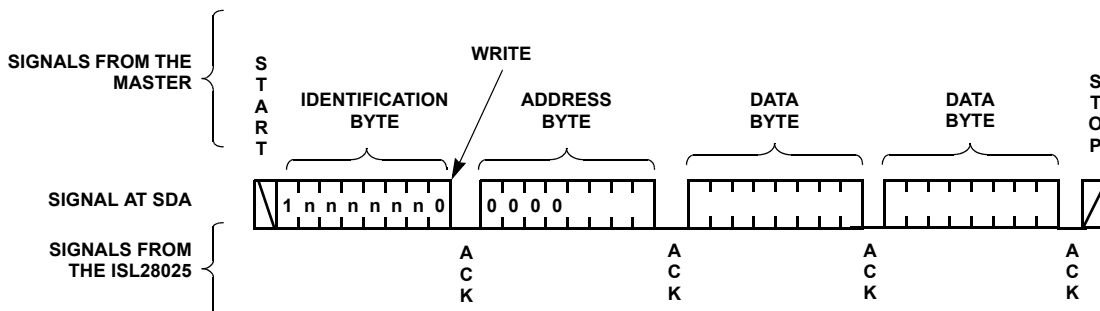

FIGURE 72. BYTE WRITE SEQUENCE (SLAVE ADDRESS INDICATED BY nnnn)

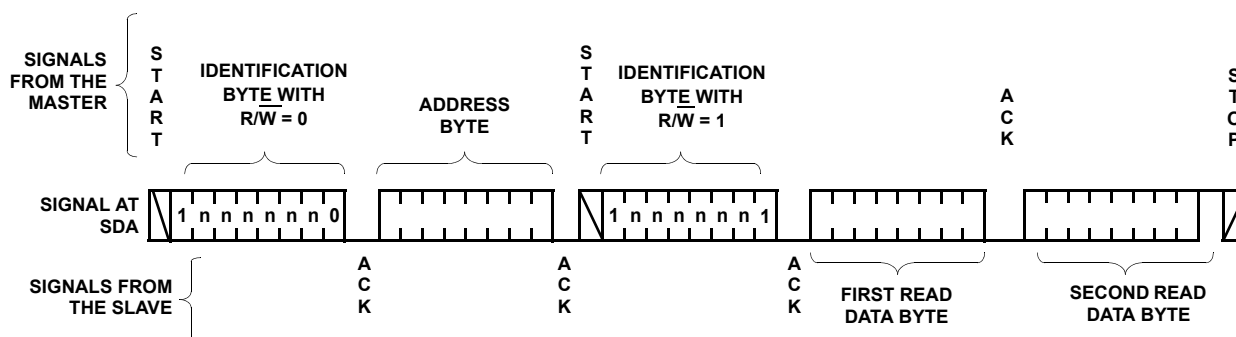

FIGURE 73. READ SEQUENCE (SLAVE ADDRESS SHOWN AS nnnn)

The last bit of the slave address byte defines a read or write operation to be performed. When this  $R/\bar{W}$  bit is a “1”, a read operation is selected. A “0” selects a write operation (refer to [Figure 72](#)).

After loading the entire slave address byte from the SDA bus, the device compares with the internal slave address. Upon a correct compare, the device outputs an acknowledge on the SDA line.

Following the slave byte is a one byte word address. The word address is either supplied by the master device or obtained from an internal counter. On power-up, the internal address counter is set to address 00h, so a current address read starts at address 00h. When required, as part of a random read, the master must supply the one word address bytes, as shown in [Figure 73](#).

In a random read operation, the slave byte in the “dummy write” portion must match the slave byte in the “read” section. For a random read of the registers, the slave byte must be “1nnnnnx” in both places.

## Write Operation

A write operation requires a START condition, followed by a valid identification byte, a valid Address byte, two data bytes and a STOP condition. The first data byte contains the MSB of the data, the second contains the LSB. After each of the four bytes, the device responds with an ACK. At this time, the I<sup>2</sup>C interface enters a standby state.

## Read Operation

A read operation consists of a three byte instruction, followed by two data bytes (see [Figure 73](#)). The master initiates the operation issuing the following sequence: A START, the identification byte with the  $R/\bar{W}$  bit set to “0”, an address byte, a second START and a second identification byte with the  $R/\bar{W}$  bit set to “1”. After each of the three bytes, the ISL28025 responds with an ACK. Then the ISL28025 transmits two data bytes as long as the master responds with an ACK during the SCL cycle following the eighth bit of the first byte. The master terminates the read operation (issuing no ACK then a STOP condition) following the last bit of the second data byte (see [Figure 73](#)).

The data bytes are from the memory location indicated by an internal pointer. This pointer’s initial value is determined by the address byte in the read operation instruction and increments by one during transmission of each pair of data bytes.

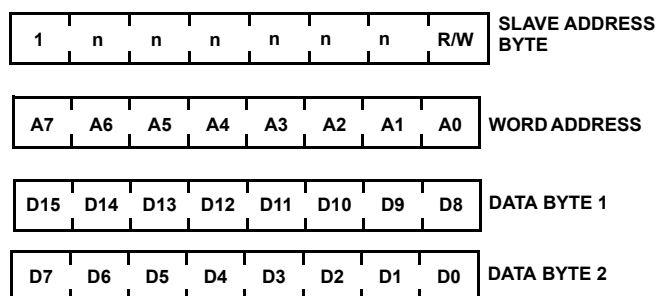

FIGURE 74. SLAVE ADDRESS, WORD ADDRESS AND DATA BYTES

## Group Command

The DPM has a feature that allows the master to configure the settings of all DPM chips at once. The configuration command for each device does not have to be same. Device 1 on an I<sup>2</sup>C bus could be configured to set the voltage threshold of the OV comparator while device 2 is configured for the acquisition time of the  $V_{BUS}$  input. To achieve the scenario described without group command, the master sends two write commands, one to each slave device. Each command sent from the master has a start bit and a stop bit. The group command protocol concatenates the two commands but replaces the stop bit of the first command and the start bit of the second command with a repeat start bit. The actions sent in a Group Command format will execute once the stop bit has been sent. The stop bit signifies the end of a packet.

The broadcast feature saves time in configuring the DPM as well as measuring signal parameters in time synchronization. The broadcast should not be used for DPM read backs. This will cause all devices connected to the I<sup>2</sup>C bus to talk to the master simultaneously.

## Clock Speed

The device supports high-speed digital transactions up to 3.4Mbps. To access the high speed I<sup>2</sup>C feature, a master byte code of 0000 1xxx is attached to the beginning of a standard frequency read/write I<sup>2</sup>C protocol. The x in the master byte signifies a do not care state. X can either equal a 0 or a 1. The master byte code should be clocked into the chip at frequencies equal or less than 400kHz. The master code command configures the internal filters of the ISL28025 to permit data bit frequencies greater than 400kHz. Once the master code has been clocked into the device, the protocol for a standard read/write transaction is followed. The frequency at which the



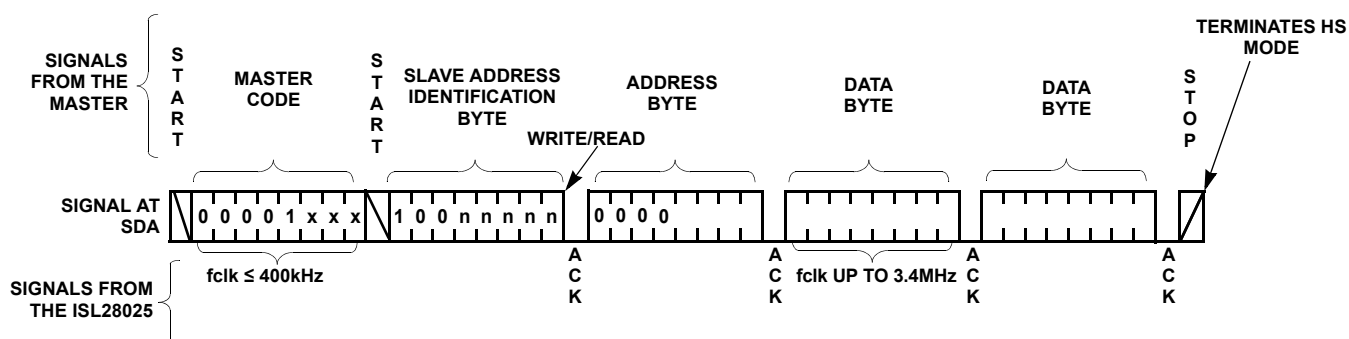

FIGURE 75. BYTE TRANSACTION SEQUENCE FOR INITIATING DATA RATES ABOVE 400kbps

standard protocol is clocked in at can be as great as 3.4MHz. A stop bit at the end of a standard protocol will terminate the high speed transaction mode. Appending another standard protocol serial transaction to the data string without a stop bit, will resume the high speed digital transaction mode. [Figure 75](#) illustrates the data sequence for the high speed mode. The minimum I<sup>2</sup>C supply voltage when operating at clock speeds 400kHz is 1.8V.

## Signal Integrity

A filter stage should be considered to limit the effects of common mode signals from bleeding into the measurement made by the ADC. The filter attenuates the amplitude of the unwanted signal to the noise level of the ISL28025. [Figure 76](#) is a simple filter example to attenuate unwanted signals.

Measuring large currents require low value sense resistors. A large valued capacitor is required to filter low frequencies if the shunt capacitor,  $C_{SH}$  is connected directly in parallel to the sense resistor,  $R_{SH}$ . For more manageable capacitor values, it may be better to directly connect the shunt resistor across the shunt inputs of the ISL28025. The connection is illustrated in [Figure 76](#). A single pole filter constructed of 2 resistors,  $R_1$ , and  $R_{SH}$  will improve capacitor value selections for low frequency filtering.

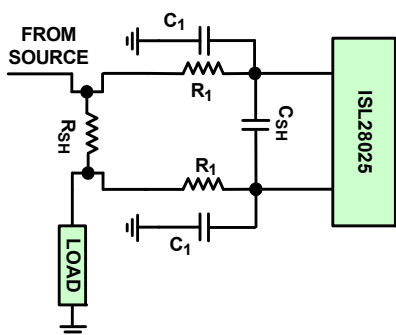

FIGURE 76. SIMPLIFIED FILTER DESIGN TO IMPROVE NOISE PERFORMANCE TO THE ISL28025

$R_1$  and  $C_1$  at both shunt inputs are single-ended low pass filters. The value of the series resistor to the ISL28025 can be a larger value than the shunt resistor,  $R_{SH}$ . A larger series resistor to the input allows for a lower cutoff frequency filter design to the ISL28025. The ISL28025 inputs can source up to 20 $\mu$ A of transient current in the measurement mode. The transient or switching offset current can be as large as 10 $\mu$ A. The switching offset current combined with the series resistance,  $R_1$ , creates an error offset voltage. A balance of the value of  $R_1$  and the shunt measurement error should be achieved for this filter design.

The common mode voltage of the shunt input stage ranges from 0V to 60V. The capacitor voltage rating for  $C_1$  and  $C_{SH}$  should comply with the nominal voltage being applied to the input.

## Fast Transients

An small isolation resistor placed between ISL28025 inputs and the source is recommended. In hot swap or other fast transient events, the amplitude of a signal can exceed the recommended operating voltage of the part due to the line inductance. The isolation resistor creates a low pass filter between the device and the source. The value of the isolation resistor should not be too large. A large value isolation resistor can effect the measurement accuracy. The value of the isolation resistor combined with the offset current creates an offset voltage error at the shunt input. The input of the Bus channel is connected to the top of a precision resistor divider. The accuracy of the resistor divider determines the gain error of the Bus channel. The input resistance of the Bus channel is 600k $\Omega$ . Placing an isolation resistor of 10 $\Omega$  will change the gain error of the Bus channel by 0.0016%.

## External Clock

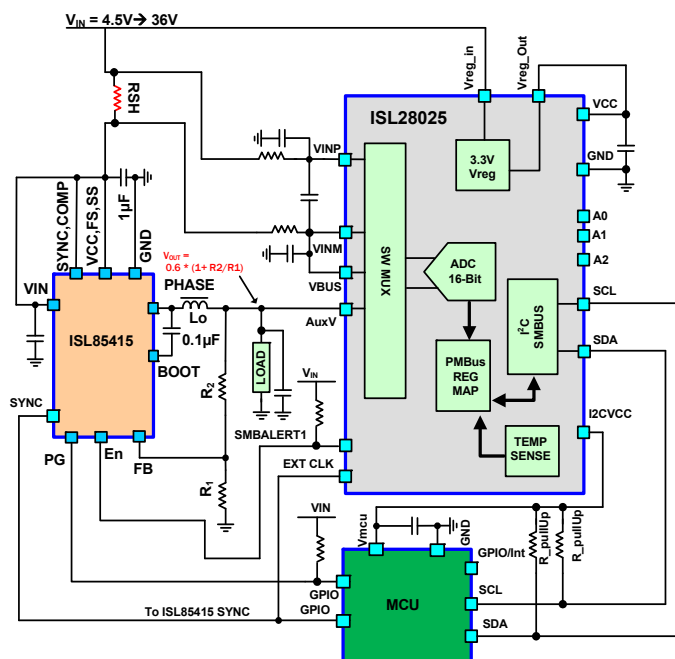
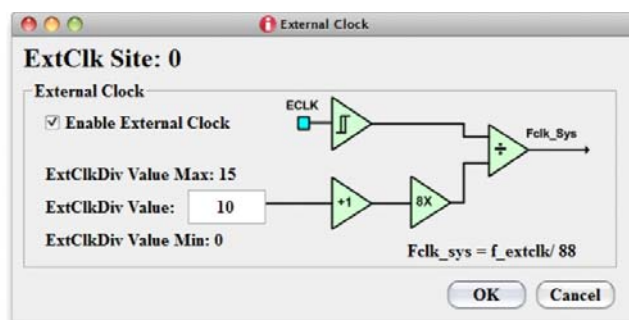

**FIGURE 77. SIMPLIFIED SCHEMATIC OF THE ISL28025 SYNCHRONIZED TO A MCU SYSTEM CLOCK**

An externally controlled clock allows measurements to be synchronized to an event that is time dependent. The event could be application generated, such as timing a current measurement to a charging capacitor in a switch regulator application or the event could be environmental. A voltage or current measurement may be susceptible to crosstalk from a controlled source. Instead of filtering the environmental noise from the measurement, another approach would be to synchronize the measurement to the source. The variability and accuracy of the measurement will improve.

The ISL28025 has the functionality to allow for synchronization to an external clock. The speed of the external clock combined with the choice of the internal chip frequency division value determines the acquisition times of the ADC. The internal system clock frequency is 500kHz. The internal system clock is also the ADC sampling clock. The acquisition times scale linearly from 500kHz. For example, an external clock frequency of 4.0MHz with a frequency divide setting of 0 (internal divide by 8) results in acquisition times that equals the internal oscillator frequency when enabled. The ADC modulator is optimized for frequencies of 500kHz. Operating internal clock frequencies beyond 500kHz may result in measurement accuracy errors due to the modulator not having enough time to settle.

Suppose an external clock frequency of 5.5MHz is applied with a divide by 88 internal frequency setting, the system clock speed is 62.5kHz or 8x slower than internal system clock. The acquisition times for this example will increase by 8. For a channel's conversion time setting of 2.048ms, the ISL28025 will have an acquisition time of 256µs.



**FIGURE 78. EXTERNAL CLOCK MODE**

Figure 78 illustrates a simple mathematical diagram of the ECLK pin internal connection. The external clock divide is controlled by way of the EXTCLKDIV bit in register 0xE5.

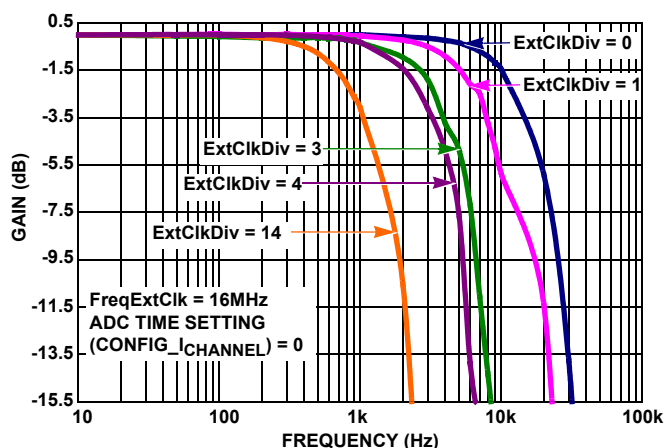

**FIGURE 79. MEASUREMENT BANDWIDTH vs EXTERNAL CLK FREQUENCY**

Figure 79 illustrates how changing the system clock frequency effects the measurement bandwidth (the ADC acquisition time).

The bandwidth of the external clock circuitry is 25MHz. Figure 80 shows the bandwidth of the external clock circuitry when the external clock division bits equals to 0.

The external clock pin can accept signal frequencies above 25MHz by programming the system clock frequency, such that the internal clock frequency is below 25MHz.



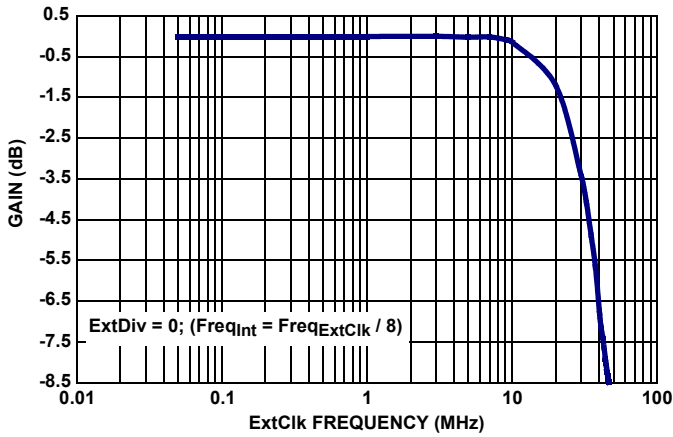

**FIGURE 80. EXTERNAL CLOCK BANDWIDTH vs MEASUREMENT ACCURACY**

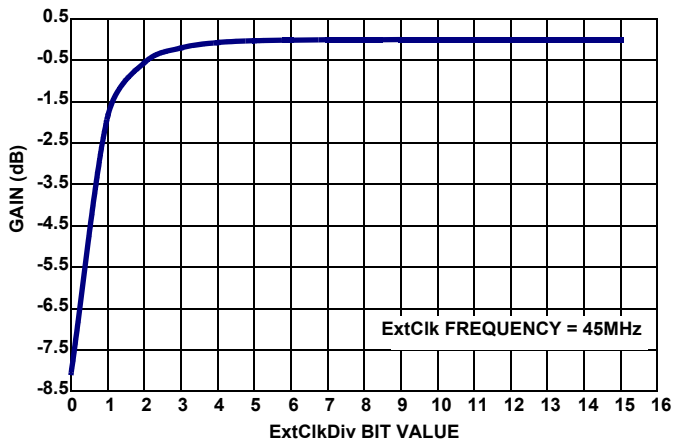

**FIGURE 81. EXTERNAL CLOCK vs EXTERNAL BIT VALUE**

Figure 81 illustrates the effects of dividing the external clock frequency on the  $V_{SHUNT}$  measurement accuracy.

Figures 80 and 81 were generated by applying a DC voltage to the  $V_{SHUNT}$  input and measuring the signal by way of an ADC conversion.

## Overranging

It is not recommended to operate the ISL28025 outside the set voltage range. In the event of measuring a shunt voltage beyond the maximum set range (80mV) and lower than the clamp voltage of the protection diode (1V), the measured output reading may be within the accepted range but will be incorrect.

## Shunt Resistor Selection

In choosing a sense resistor, the following resistor parameters need to be considered; the resistor value, resistor temperature coefficient and resistor power rating.

The sense resistor value is a function of the full-scale voltage drop across the shunt resistor and the maximum current measured for the application. The maximum measurable range for the  $V_{SHUNT}$  input ( $V_{INP} - V_{INM}$ ) of the ISL28025 is 80mV. The ISL28025 allows the user to define a unique range other than  $\pm 80$ mV.

Once the voltage range for the input is chosen and the maximum measurable current is known, the sense resistor value is calculated using Equation 14.

$$R_{sense} = \frac{V_{shunt\_range}}{I_{meas\_Max}} \quad (EQ. 14)$$

In choosing a sense resistor, the sense resistor power rating should be taken into consideration. The physical size of a sense resistor is proportional to the power rating of the resistor. The maximum power rating for the measurement system is calculated as the  $V_{shunt\_range}$  multiplied by the maximum measurable current expected. The power rating equation is represented in Equation 15.

$$P_{res\_rating} = V_{shunt\_range} \cdot I_{meas\_Max} \quad (EQ. 15)$$

A general rule of thumb is to multiply the power rating calculated in Equation 15 by 2. This allows the sense resistor to survive an event when the current passing through the shunt resistor is greater than the measurable maximum current. The higher the ratio between the power rating of the chosen sense resistor and the calculated power rating of the system (Equation 15), the less the resistor will heat up in high current applications.

The Temperature Coefficient (TC) of the sense resistor directly degrades the current measurement accuracy. The surrounding temperature of the sense resistor and the power dissipate by the resistor will cause the sense resistor value to change. The change in resistor temperature with respect to the amount of current that flows through the resistor is directly proportional to the ratio of the power rating of the resistor versus the power being dissipated. A change in sense resistor temperature results in a change in sense resistor value. Overall, the change in sense resistor value contributes to the measurement accuracy for the system. The change in a resistor value due to a temperature rise can be calculated using Equation 16

$$\Delta R_{sense} = R_{sense} \cdot R_{sense\_TC} \cdot \Delta Temperature \quad (EQ. 16)$$

$\Delta Temperature$  is the change in temperature in Celsius.  $R_{sense\_TC}$  is the temperature coefficient rating for a sense resistor.  $R_{sense}$  is the resistance value of the sense resistor at the initial temperature.

Table 46 is a shunt resistor look-up table for select full scale current measurement ranges ( $I_{measMax}$ ). The table also provides the minimum rating for each shunt resistor.

**TABLE 46. SHUNT RESISTOR VALUES AND POWER RATINGS FOR SELECT MEASURABLE CURRENT RANGES**

R <sub>SENSE</sub> /P <sub>RATING</sub>	V <sub>SHUNT</sub> RANGE (PGA SETTING)
$I_{measMax}$	80mV
100μA	800Ω/8μW
1mA	80Ω/80μW
10mA	8Ω/800μW
100mA	800mΩ/8mW
500mA	160mΩ/40mW
1A	80mΩ/80mW
5A	16mΩ/400mW
10A	8mΩ/800mW
50A	1.6mΩ/4W
100A	0.8mΩ/8W
500A	0.16mΩ/40W

It is often hard to readily purchase shunt resistor values for a desired measurable current range. Either the value of the shunt resistor does not exist or the power rating of the shunt resistor is too low. A means of circumventing the problem is to use two or more shunt resistors in parallel to set the desired current measurement range. For example, an application requires a full scale current of 100A with a maximum voltage drop across the shunt resistor of 80mV. From Table 46, this requires a sense resistor of 0.8mΩ, 8W resistor. Assume the power ratings and the shunt resistor values to chose from are 1mΩ/4W, 2mΩ/4W and 4mΩ/4W.

Let's use a 1mΩ and a 4mΩ resistor in parallel to create the shunt resistor value of 0.8mΩ. Figure 82 shows an illustration of the shunt resistors in parallel.

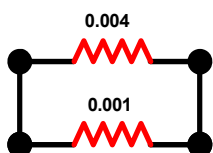
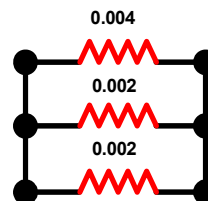

**FIGURE 82. SIMPLIFIED SCHEMATIC ILLUSTRATING THE USE OF TWO SHUNT RESISTORS TO CREATE A DESIRED SHUNT VALUE**

The power to each shunt resistor should be calculated before calling a solution complete. The power to each shunt resistor is calculated using Equation 17.

$$P_{shuntRes} = \frac{V_{shunt\_range}^2}{R_{sense}} \quad (EQ. 17)$$

The power dissipated by the 1mΩ resistor is 6.4W. 1.6W is dissipated by the 4mΩ resistor. 1.6W exceeds the rating limit of 1W for the 1mΩ sense resistor. Another approach would be to use three shunt resistors in parallel as illustrated in Figure 83.



**FIGURE 83. INCREASING THE NUMBER OF SHUNT RESISTORS IN PARALLEL TO CREATE A SHUNT RESISTOR VALUE REDUCES THE POWER DISSIPATED BY EACH SHUNT RESISTOR**

Using Equation 17, the power dissipated to each shunt resistor yields 3.2W for the 2mΩ shunt resistors and 1.6W for the 4mΩ shunt resistor. All shunt resistor are within the specified power ratings.

## Layout

The layout of a current measuring system is equally important as choosing the correct sense resistor and the correct analog converter. Poor layout techniques can result in severed traces, signal path oscillations, magnetic contamination, which all contribute to poor system performance.

## TRACE WIDTH

Matching the current carrying density of a copper trace with the maximum current that will pass through is critical in the performance of the system. Neglecting the current carrying capability of a trace will result in a large temperature rise in the trace, and the loss in system efficiency due to the increase in resistance of the copper trace. In extreme cases, the copper trace could be severed because the trace could not pass the current. The current carrying capability of a trace is calculated using Equation 18.

$$\text{Trace width} = \frac{1}{\left( \frac{I_{max}}{k \cdot \Delta T} \right)^{0.44}} \quad (EQ. 18)$$

$I_{max}$  is the largest current expected to pass through the trace.  $\Delta T$  is the allowable temperature rise in Celsius when the maximum current passes through the trace.  $\text{Trace}_{Thickness}$  is the thickness of the trace specified to the PCB fabricator in mils. A typical thickness for general current carrying applications (<100mA) is 0.5oz. copper or 0.7mils. For larger currents, the trace thickness should be greater than 1.0oz. or 1.4mils. A balance between thickness, width and cost needs to be achieved for each design. The coefficient  $k$  in Equation 18 changes depending on the trace location. For external traces, the value of  $k$  equals 0.048 while for internal traces the value of  $k$  reduces to 0.024. The  $k$  values and Equation 18 are stated per the ANSI IPC-2221(A) standards.

## TRACE ROUTING

It is always advised to make the distance between voltage source, sense resistor and load as close as possible. The longer the trace length between components will result in voltage drops between components. The additional resistance will reduce the efficiency of a system.

The bulk resistance,  $\rho$ , of copper is  $0.67\mu\Omega/\text{in}$  or  $1.7\mu\Omega/\text{cm}$  at  $+25^\circ\text{C}$ . The resistance of trace can be calculated from [Equation 19](#).

$$R_{\text{trace}} = \rho \cdot \frac{\text{Trace length}}{\text{Trace width} \cdot \text{Trace thickness}} \quad (\text{EQ. 19})$$

[Figure 84](#) illustrates each dimension of a trace.

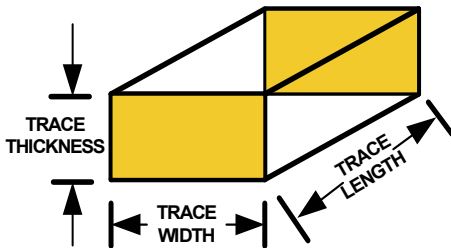

**FIGURE 84. ILLUSTRATION OF THE TRACE DIMENSIONS OF A STRIP LINE TRACE**

For example, assume a trace has 2oz. of copper or 2.8mil thickness, a width of 100mil and a length of 0.5in. Using [Equation 19](#), the resistance of the trace is approximately  $2\text{m}\Omega$ . Assume 1A of current is passing through the trace. A 2mV voltage drop would result from trace routing.

Current flowing through a conductor will take the path of least resistance. When routing a trace, avoid orthogonal connections for current bearing traces.

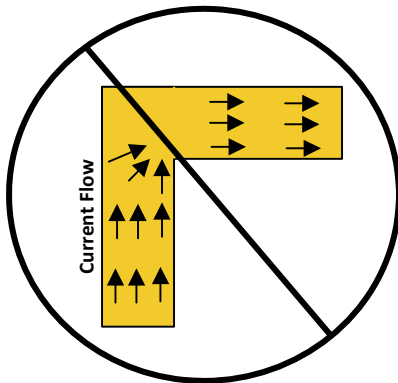

**FIGURE 85. AVOID ROUTING ORTHOGONAL CONNECTIONS FOR TRACES THAT HAVE HIGH CURRENT FLOWS.**

Orthogonal routing for high current flow traces will result in current crowding, localized heating of the trace and a change in trace resistance.

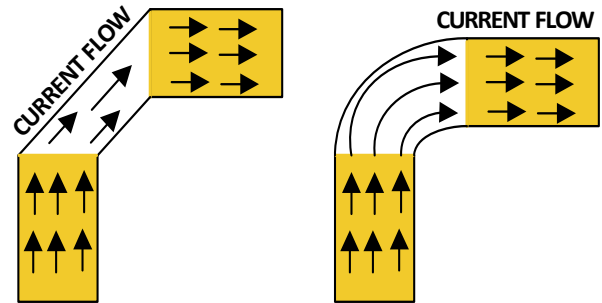

**FIGURE 86. USE ARCS AND 45° TRACES TO SAFELY ROUTE TRACES WITH LARGE CURRENT FLOWS**

The utilization of arcs and  $45^\circ$  traces in routing large current flow traces will maintain uniform current flow throughout the trace. [Figure 86](#) illustrates the routing technique.

## CONNECTING SENSE TRACES TO THE CURRENT SENSE RESISTOR

Ideally, a 4 terminal current sense resistor would be used as the sensing element. Four terminal sensor resistors can be hard to find in specific values and in sizes. Often a two terminal sense resistor is designed into the application.

Sense lines are high impedance by definition. The connection point of a high impedance line reflects the voltage at the intersection of a current bearing trace and a high impedance trace.

The high impedance trace should connect at the intersection where the sense resistor meets the landing pad on the PCB. The best place to make current sense line connection is on the inner side of the sense resistor footprint. The illustration of the connection is shown in [Figure 87](#). Most of the current flow is at the outer edge of the footprint. The current ceases at the point the sense resistor connects to the landing pad. Assume the sense resistor connects at the middle of each landing pad, this leaves the inner half of each landing pad with little current flow. With little current flow, the inner half of each landing pad is classified as high impedance and perfect for a sense connection.

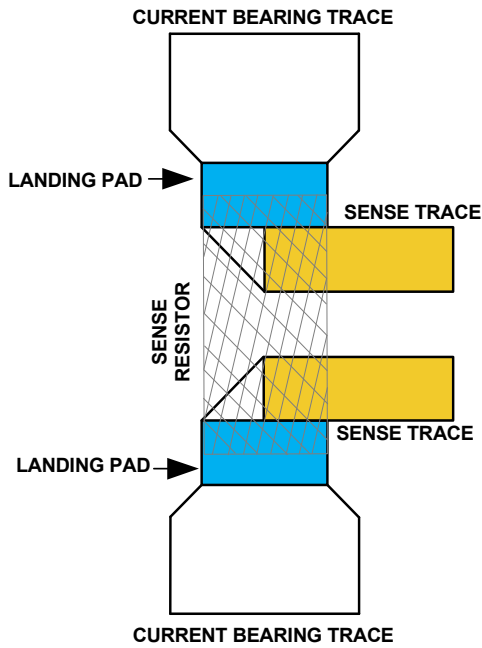
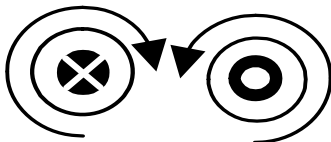

FIGURE 87. CONNECTING THE SENSE LINES TO A CURRENT SENSE RESISTOR

Current sense resistors are often smaller than the width of the traces that connect to the footprint. The trace connecting to the footprint is tapered at a 45° angle to control the uniformity of the current flow.

**MAGNETIC INTERFERENCE**

The magnetic field generated from a trace is directly proportional to the current passing through the trace and the distance from the trace the field is being measured at. Figure 88 illustrates the direction the magnetic field flows versus current flow.



$$B = \frac{\mu_0 \cdot I}{2 \cdot \pi \cdot r}$$

FIGURE 88. THE CONDUCTOR ON THE LEFT SHOWS THE MAGNETIC FIELD FLOWING IN A CLOCKWISE DIRECTION FOR CURRENTS FLOWING INTO THE PAGE. CURRENT FLOW OUT OF THE PAGE HAS A COUNTER CLOCKWISE MAGNETIC FLOW

The equation in Figure 88 determines the magnetic field, B, the trace generates in relation to the current passing through the trace, I, and the distance the magnetic field is being measured from the conductor, r. The permeability of air,  $\mu_0$ , is  $4\pi \cdot 10^{-7}$  H/m.

When routing high current traces, avoid routing high impedance traces in parallel with high current bearing traces. A means of limiting the magnetic interference from high current traces is to closely route the paths connected to and from the sense resistor. The magnetic fields will cancel outside the two traces and add between the two traces. Figure 89 illustrates a magnetic field insensitive layout.

If possible, do not cross traces with high current. If a trace crossing cannot be avoided, cross the trace in an orthogonal manor and the furthest layer from the current bearing trace. The inference from the current bearing trace will be limited.

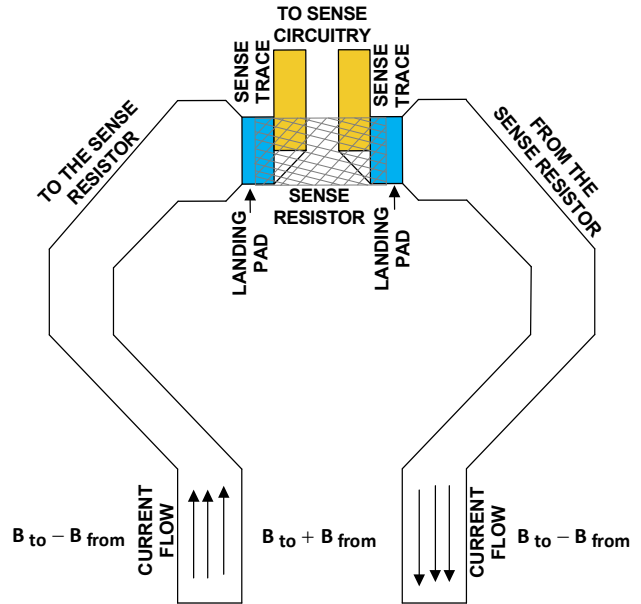

FIGURE 89. CLOSELY ROUTED TRACES THAT CONNECT TO THE SENSE RESISTOR REDUCES THE MAGNETIC INTERFERENCE SOURCED FROM THE CURRENT FLOWING THROUGH THE TRACES

**A Trace as a Sense Resistor**

In previous sections, the resistance and the current carrying capabilities of a trace were discussed. In high current sense applications, a design may utilize the resistivity of a current sense trace as the sense resistor. This section will discuss how to design a sense resistor from a copper trace.

Suppose an application needs to measure current up to 200A. The design requires the least amount of voltage drop for maximum efficiency. The full scale voltage range of 40mV is chosen. From Ohms law, the sense resistor is calculated to be 200μΩ. The power rating of the resistor is calculated to be 8W. Assume the PCB trace thickness of the board equals 2oz./2.8mils and the maximum temperature rise of the trace is +20° C. Using Equation 18 on page 42, the calculated trace width is 2.192in. The trace width, thickness and the desired sense resistor value is known. Utilizing Equation 19 on page 43, the trace length is calculated to be 1.832in.

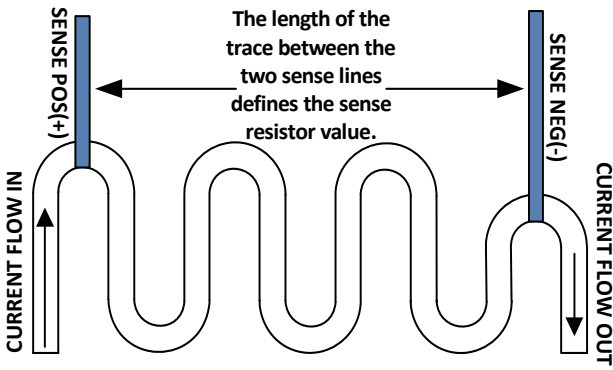

FIGURE 90. ILLUSTRATES A LAYOUT EXAMPLE OF A CURRENT SENSE RESISTOR MADE FROM A PCB TRACE

Figure 90 illustrates a layout example of a current sense resistor defined by a PCB trace. The serpentine pattern of the resistor reduces current crowding as well as limiting the magnetic interference caused by the current flowing through the trace.

For the example discussed, the width of the trace in Figure 90 illustration would equal 2.192in and the length between the sense lines equals 1.832in.

The width of the resistor is long for some applications. A means of shortening the trace width is to connect two traces in parallel. For calculation ease, assume the resistive traces are routed on the outside layers of a PCB. Using Equations 18 and 19, the width of the trace is reduced from 2.192in to 1.096in.

When using multiple layers to create a trace resistor, use multiple vias to keep the trace potentials between the two conductors the same. Vias are highly resistive compared to a copper trace. Multiple vias should be employed to lower the voltage drop due to current flowing through resistive vias.

Figure 91 illustrates a layout technique for a multiple layered trace sense resistor.

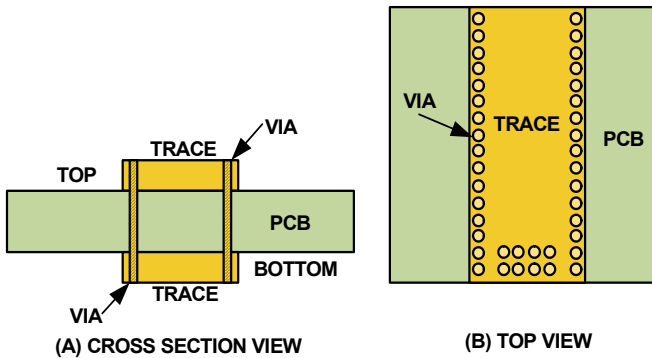

FIGURE 91. ILLUSTRATES A LAYOUT EXAMPLE OF A MULTIPLE LAYER TRACE RESISTOR

### Lossless Current Sensing (DCR)

A DCR sense circuit is an alternative to a sense resistor. The DCR circuit utilizes the parasitic resistance of an inductor to measure the current to the load. A DCR circuit remotely measures the current through an inductor. The lack of components in series with the regulator to the load makes the circuit lossless.

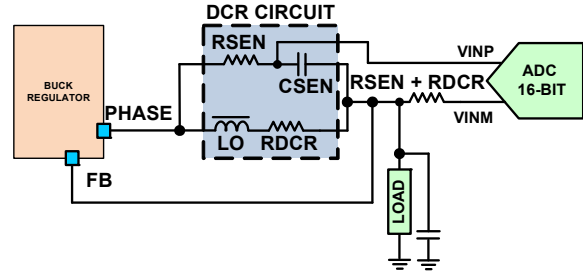

FIGURE 92. SIMPLIFIED CIRCUIT EXAMPLE OF A DCR

A properly matched DCR circuit has an equivalent circuit seen by the ADC equals to  $R_{dcr}$  in Figure 92. Before deriving the transfer function between the inductor current and voltage seen by the ISL28025, let's review the definition of an inductor and capacitor in the Laplacian domain.

$$X_C(f) = \frac{1}{j \cdot \omega(f) \cdot C} \quad X_L(f) = j \cdot \omega(f) \cdot L \quad (EQ. 20)$$

$X_C$  is the impedance of a capacitor related to the frequency and  $X_L$  is the impedance of an inductor related to frequency.  $\omega$  equals to  $2\pi f$ .  $f$  is the chop frequency dictated by the regulator. Using Ohms law, the voltage across the DCR circuit in terms of the current flowing through the inductor is define in Equation 21.

$$V_{dcr}(f) = (R_{dcr} + j \cdot \omega(f) \cdot L) \cdot i_L \quad (EQ. 21)$$

In Equation 21,  $R_{dcr}$  is the parasitic resistance of the inductor. The voltage drop across the inductor ( $L_o$ ) and the resistor ( $R_{dcr}$ ) circuit is the same as the voltage drop across the resistor ( $R_{sen}$ ) and the capacitor ( $C_{sen}$ ) circuit. Equation 22 defines the voltage across the capacitor ( $V_{cSEN}$ ) in terms of the inductor current ( $i_L$ ).

$$V_C(f) = \frac{(j \cdot \omega(f) \cdot L + R_{dcr})}{1 + j \cdot \omega(f) \cdot C_{sen} \cdot R_{sen}} = R_{dcr} \cdot \frac{\left[ 1 + \frac{(j \cdot \omega(f) \cdot L)}{R_{dcr}} \right]}{1 + j \cdot \omega(f) \cdot C_{sen} \cdot R_{sen}} \cdot i_L \quad (EQ. 22)$$

The relationship between the inductor load current ( $i_L$ ) and the voltage across capacitor simplifies if the following component selection holds true;

$$\frac{L}{R_{dcr}} = C_{sen} \cdot R_{sen} \quad (EQ. 23)$$

# ISL28025

If [Equation 23](#) holds true, the numerator and denominator of the fraction in [Equation 22](#) cancels reducing the voltage across the capacitor to the equation represented in [Equation 24](#).

$$V_c = R_{dcr} \cdot i_L \quad (\text{EQ. 24})$$

Most inductor datasheets will specify the average value of the  $R_{dcr}$  for the inductor.  $R_{dcr}$  values are usually sub  $1\text{m}\Omega$  with a tolerance averaging 8%. Common chip capacitor tolerances average to 10%.

Inductors are constructed out of metal. Metal has a high temperature coefficient. The temperature drift of the inductor value could cause the DCR circuit to be untuned. An untuned

circuit results in inaccurate current measurements along with a chop signal bleeding into the measurement. To counter the temperature variance, a temperature sensor may be incorporated into the design to track the change in component values.

A DCR circuit is good for gross current measurements. As discussed, inductors and capacitors have high tolerances and are temperature dependent, which will result in less than accurate current measurements.

In [Figure 92](#), there is a resistor in series with the ISL28025 negative shunt terminal, VINM, with the value of  $R_{sen} + R_{dcr}$ . The resistor's purpose is to counter the effects of the bias current from creating a voltage offset at the input of the ADC.

## Revision History

The revision history provided is for informational purposes only and is believed to be accurate, but not warranted. Please go to the web to make sure that you have the latest revision.

DATE	REVISION	CHANGE
June 17, 2015	FN8388.3	Added Related Literature section on page 1. Added DPM Portfolio Comparison table on page 5. Removed Typical Applications section (which included Figure 102) and made into an appnote (AN1955).
February 17, 2015	FN8388.2	Changed Reference of ZL9050 in Figure 102 on page 51 to ISL8272M.
October 24, 2014	FN8388.1	"Vbus_OV_OT_Set D[5:0]" on page 29, changed step size from "1.95°" to "5.71° C" and added "The mathematical range is -144° C to +221.4° C". Updated Table 23 on page 30 by adding column OT THRESHOLD VALUE. Changed title of Table 29 on page 31 from "Vbus_OV_OT_Set BITS DEFINED" to "Vshunt_OC_Set BITS DEFINED".
June 30, 2014	FN8388.0	Initial Release

## About Intersil

Intersil Corporation is a leading provider of innovative power management and precision analog solutions. The company's products address some of the largest markets within the industrial and infrastructure, mobile computing and high-end consumer markets.

For the most updated datasheet, application notes, related documentation and related parts, please see the respective product information page found at [www.intersil.com](http://www.intersil.com).

You may report errors or suggestions for improving this datasheet by visiting [www.intersil.com/ask](http://www.intersil.com/ask).

Reliability reports are also available from our website at [www.intersil.com/support](http://www.intersil.com/support)

For additional products, see [www.intersil.com/en/products.html](http://www.intersil.com/en/products.html)

Intersil products are manufactured, assembled and tested utilizing ISO9001 quality systems as noted in the quality certifications found at [www.intersil.com/en/support/qualandreliability.html](http://www.intersil.com/en/support/qualandreliability.html)

*Intersil products are sold by description only. Intersil Corporation reserves the right to make changes in circuit design, software and/or specifications at any time without notice. Accordingly, the reader is cautioned to verify that data sheets are current before placing orders. Information furnished by Intersil is believed to be accurate and reliable. However, no responsibility is assumed by Intersil or its subsidiaries for its use; nor for any infringements of patents or other rights of third parties which may result from its use. No license is granted by implication or otherwise under any patent or patent rights of Intersil or its subsidiaries.*

For information regarding Intersil Corporation and its products, see [www.intersil.com](http://www.intersil.com)

## Package Outline Drawing W4x4.16C

(WLCSP 0.5mm PITCH) WAFER LEVEL CHIP SCALE PACKAGE

Rev 1, 05/14

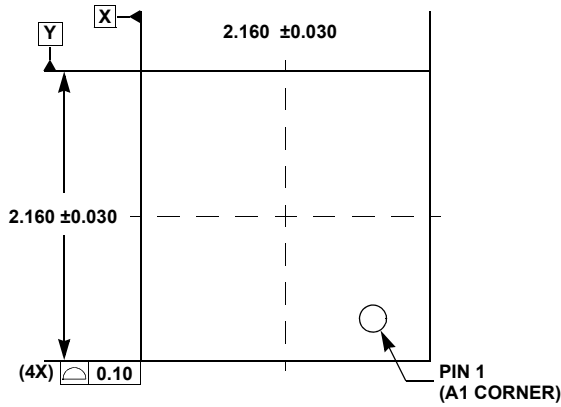

**TOP VIEW**

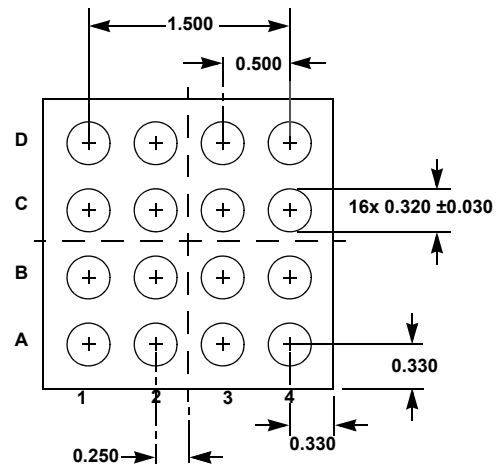

**BOTTOM VIEW**

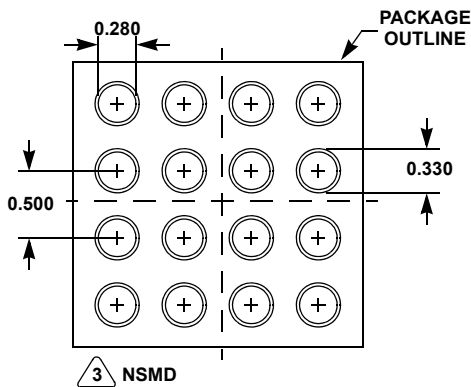

**RECOMMENDED LAND PATTERN**

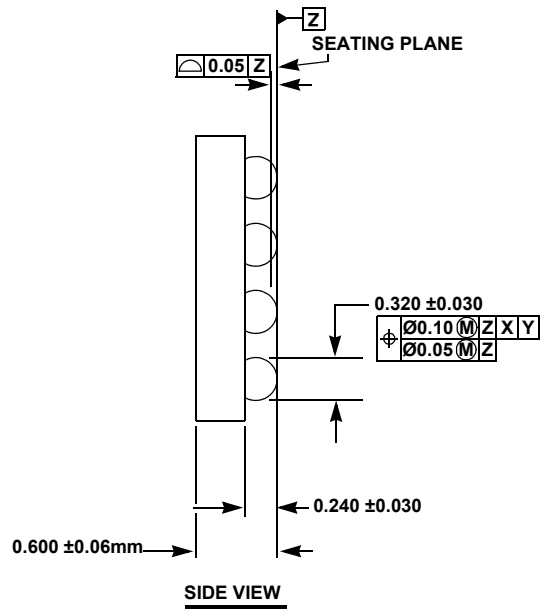

**SIDE VIEW**

**NOTES:**

1. All dimensions are in millimeters.
2. Dimension and tolerance per ASMEY 14.5M-1994, and JESD 95-1 SPP-010.
3. NSMD refers to non-solder mask defined pad design per Intersil Techbrief [TB451](#).